

User Manual



1503C Metallic Time-Domain Reflectometer 070-7323-05

This document applies to firmware version 5.04
and above.

www.tektronix.com

Copyright © Tektronix, Inc. All rights reserved.

Tektronix products are covered by U.S. and foreign patents, issued and pending. Information in this publication supercedes that in all previously published material. Specifications and price change privileges reserved.

Tektronix, Inc., P.O. Box 500, Beaverton, OR 97077

TEKTRONIX and TEK are registered trademarks of Tektronix, Inc.

WARRANTY

Tektronix warrants that the products that it manufactures and sells will be free from defects in materials and workmanship for a period of one (1) year from the date of shipment. If a product proves defective during this warranty period, Tektronix, at its option, either will repair the defective product without charge for parts and labor, or will provide a replacement in exchange for the defective product.

In order to obtain service under this warranty, Customer must notify Tektronix of the defect before the expiration of the warranty period and make suitable arrangements for the performance of service. Customer shall be responsible for packaging and shipping the defective product to the service center designated by Tektronix, with shipping charges prepaid. Tektronix shall pay for the return of the product to Customer if the shipment is to a location within the country in which the Tektronix service center is located. Customer shall be responsible for paying all shipping charges, duties, taxes, and any other charges for products returned to any other locations.

This warranty shall not apply to any defect, failure or damage caused by improper use or improper or inadequate maintenance and care. Tektronix shall not be obligated to furnish service under this warranty a) to repair damage resulting from attempts by personnel other than Tektronix representatives to install, repair or service the product; b) to repair damage resulting from improper use or connection to incompatible equipment; c) to repair any damage or malfunction caused by the use of non-Tektronix supplies; or d) to service a product that has been modified or integrated with other products when the effect of such modification or integration increases the time or difficulty of servicing the product.

THIS WARRANTY IS GIVEN BY TEKTRONIX IN LIEU OF ANY OTHER WARRANTIES, EXPRESS OR IMPLIED. TEKTRONIX AND ITS VENDORS DISCLAIM ANY IMPLIED WARRANTIES OF MERCHANTABILITY OR FITNESS FOR A PARTICULAR PURPOSE. TEKTRONIX' RESPONSIBILITY TO REPAIR OR REPLACE DEFECTIVE PRODUCTS IS THE SOLE AND EXCLUSIVE REMEDY PROVIDED TO THE CUSTOMER FOR BREACH OF THIS WARRANTY. TEKTRONIX AND ITS VENDORS WILL NOT BE LIABLE FOR ANY INDIRECT, SPECIAL, INCIDENTAL, OR CONSEQUENTIAL DAMAGES IRRESPECTIVE OF WHETHER TEKTRONIX OR THE VENDOR HAS ADVANCE NOTICE OF THE POSSIBILITY OF SUCH DAMAGES.

Table of Contents

List of Figures	iii
List of Tables	vi
General Information	vii
Installation and Repacking	viii
Contacting Tektronix	x
General Safety Summary	xiii
Operating Instructions	1-1
Overview	1-1
Preparing to Use the 1503C	1-4
Display	1-5
Front-Panel Controls	1-5
Menu Selections	1-7
Test Preparations	1-10
Cable Test Procedure	1-12
Additional Features (Menu Selected)	1-24
Operator Tutorial	2-1
What is the Tektronix 1503C?	2-1
How Does It Do It?	2-1
You, the Operator	2-1
Menus and Help	2-1
Getting Started	2-2
The Waveform Up Close	2-4
A Longer Cable	2-6
Noise	2-9
Set Ref (Δ Mode)	2-11
VIEW INPUT	2-14
STORE and VIEW STORE	2-15
VIEW DIFF	2-17

Menu-Accessed Functions	2-18
TDR Questions and Answers	2-23
Options and Accessories	3-1
Option 04: YT-1 Chart Recorder	3-1
Option 05: Metric Default	3-1
Option 06: Ethernet)	3-1
Option 07: YT-1S Chart Recorder	3-17
Option 08: Token Ring Adapter	3-17
Option 09: Universal Service Ordering Code	3-18
Option 10: Token Ring Interface	3-18
Power Cord Options	3-18
Accessories	3-19
Appendix A: Specifications	A-1
Electrical Characteristics	A-1
Environmental Characteristics	A-3
Certifications and Compliances	A-4
Physical Characteristics	A-5
Appendix B: Operator Performance Checks	B-1
Appendix C: Operator Troubleshooting	C-1
Error Messages	C-3
Appendix D: Application Note	D-1
Glossary	Glossary-1
Index	Index-1

List of Figures

Figure 1-1: Rear Panel Voltage Selector, Fuse, AC Receptacle	1-1
Figure 1-2: Display Showing Low Battery Indication	1-3
Figure 1-3: 1503C Front-Panel Controls	1-4
Figure 1-4: Display and Indicators	1-5
Figure 1-5: V _p Set at .30, Cursor Beyond Reflected Pulse (Setting Too Low)	1-11
Figure 1-6: V _p Set at .99, Cursor Less Than Reflected Pulse (Setting Too High)	1-12
Figure 1-7: V _p Set at .66, Cursor on Rising Edge of Reflected Pulse (Set Correctly)	1-12
Figure 1-8: 20-ft Cable at 5 ft/div	1-13
Figure 1-9: Short in the Cable	1-13
Figure 1-10: Open in the Cable	1-14
Figure 1-11: 455-ft Cable	1-14
Figure 1-12: 455-ft Cable with 20 ft/div, Cursor Off Screen	1-15
Figure 1-13: Return Loss	1-15
Figure 1-14: Reflection Adjusted to One Division in Height	1-16
Figure 1-15: Display with VIEW INPUT Turned Off	1-17
Figure 1-16: Display of a Stored Waveform	1-18
Figure 1-17: Display of a Stored Waveform and Current Waveform	1-18
Figure 1-18: Display of a Stored Waveform, Current Waveform, and Difference Waveform	1-19
Figure 1-19: Waveform Moved to Top Half of Display	1-19
Figure 1-20: Current Waveform Centered, Stored Waveform Above	1-20
Figure 1-21: Current Waveform Center, Stored Waveform Above, Difference Below	1-20
Figure 1-22: Waveform of Three-Foot Lead-in Cable	1-21
Figure 1-23: Cursor Moved to End of Three-Foot Lead-in Cable	1-22
Figure 1-24: Cursor Moved to End of Three-Foot Lead-in Cable	1-22
Figure 1-25: Cursor Moved to 0.00 ft	1-23
Figure 1-26: Incident Pulse at Four Divisions, FILTER at Desired Setting	1-23
Figure 1-27: Waveform Viewed in Normal Operation	1-24
Figure 1-28: Waveform Showing Intermittent Short	1-25
Figure 1-29: Waveform Display with No Outgoing Pulses	1-25

Figure 1–30: A Captured Single Sweep	1–26
Figure 2–1: Display Showing 10-ft Cable in Start-Up Conditions	2–2
Figure 2–2: Cursor of Rising Edge of Reflected Pulse	2–3
Figure 2–3: Waveform with VERT SCALE Increased Showing an Open	2–3
Figure 2–4: Waveform with Short	2–4
Figure 2–5: 10-foot Cable with Cursor at Far Left	2–4
Figure 2–6: 10-foot Cable with Cursor at Incident Pulse	2–5
Figure 2–7: 10-foot Cable with Cursor at Incident Pulse, Vertical Scale at 25 dB	2–5
Figure 2–8: Cursor on End of Longer Cable	2–6
Figure 2–9: Scrolling Down the Cable	2–7
Figure 2–10: Pulse Width at 2 ns	2–7
Figure 2–11: Pulse Width at 10 ns	2–8
Figure 2–12: Pulse Width at 100 ns	2–8
Figure 2–13: Pulse Width at 1000 ns, Longer than the Cable Being Tested	2–8
Figure 2–14: Noise on the Waveform.	2–9
Figure 2–15: Noise Reduced.	2–10
Figure 2–16: Noise Reduced to Minimum	2–10
Figure 2–17: Incident and Reflected Pulses with Cursor at 0.00 ft	2–11
Figure 2–18: Incident and Reflected Pulses with Cursor at 10.0 ft	2–12
Figure 2–19: New Zero Set at End of Test Cable	2–12
Figure 2–20: Display with 10-ft Cable and NOISE FILTER turned to VERT SET REF	2–13
Figure 2–21: VERT SCALE adjusted to Make Pulse Two Divisions High	2–13
Figure 2–22: Filter Returned to Desired Setting	2–14
Figure 2–23: Display with VIEW INPUT Turned Off	2–15
Figure 2–24: Display with VIEW INPUT Turned On	2–15
Figure 2–25: Waveform Moved to Upper Portion of the Display	2–16
Figure 2–26: Waveform with Cable Shorted	2–16
Figure 2–27: Waveform with Both Current and Stored Waveforms	2–17
Figure 2–28: Stored, Current, and Difference Waveforms	2–17
Figure 2–29: Display with VIEW STORE and VIEW DIFF Disabled.	2–19
Figure 2–30: Short and Open Viewed via Max Hold	2–19
Figure 2–31: Waveform Strobed Down Display in Max Hold	2–19
Figure 2–32: Display with Pulse Turned Off	2–21

Figure 2–33: Test Cable	2–22
Figure 2–34: Shorted Test Cable with a Captured Single Sweep	2–22
Figure 3–1: A Typical Ethernet System	3–3
Figure 3–2: N-Type Male T-Connector	3–5
Figure 3–3: N-Type Female T-Connector	3–6
Figure 3–4: System 1 – Tap Hidden by Traffic (1 avg, 50 ft/div, 35 dB)	3–11
Figure 3–5: System 1 – Traffic and Tap Nearly Identical (4 avg, 50 ft/div, 35 dB)	3–11
Figure 3–6: System 1 – Tap Becoming Visible (16 avg, 50 ft/div, 35 dB)	3–11
Figure 3–7: System 1 – Tap Quite Visible (128 avg, 50 ft/div, 35 dB)	3–12
Figure 3–8: System 1 – No Traffic (1 avg, 50 ft/div, 35 dB)	3–12
Figure 3–9: System 1 – Tap Expanded, No Traffic (1 avg, 2 ft/div, 35 dB)	3–12
Figure 3–10: System 2 – Cable w/ Revision One Repeater (1 avg, 200ft/div, 2.25dB)	3–13
Figure 3–11: System 2 – First Tap, No Traffic (1 avg, 1 ft/div, 44.5 dB)	3–13
Figure 3–12: System 2 – Same Tap with 5% Traffic (1 avg, 1 ft/div, 44.5 dB)	3–13
Figure 3–13: System 2 – Same Tap, Increased Averaging (16 avg, 1 ft/div, 44.5 dB)	3–14
Figure 3–14: System 2 – Farther Out, More Gain (128 avg, 10 ft/div, 53.5 dB)	3–14
Figure 3–15: System 2 – 1000-ft Cable at 10 ns (128 avg, 100 ft/div, 43.75 dB)	3–14
Figure 3–16: System 2 – Previous Waveform Expanded (128 avg, 20 ft/div, 54.75 dB)	3–15
Figure 3–17: System 2 – Next Group of Taps (128 avg, 20 ft/div, 54.75 dB)	3–15
Figure 3–18: System 2 – Group of Taps Expanded (128 avg, 10 ft/div, 54.75 dB)	3–15
Figure 3–19: System 2 – Another Group of Taps (128 avg, 10 ft/div, 54.75 dB)	3–16
Figure 3–20: System 2 – End of Cable (128 avg, 20 ft/div, 61.25 dB)	3–16
Figure 3–21: Typical Frequency Response Curve with Ethernet Option 06	3–17

Figure B–1: Start-up Measurement Display	B–2
Figure B–2: Measurement Display with 10-foot Cable	B–2
Figure B–3: Cursor at End of 10-foot Cable	B–3
Figure B–4: Cursor at End of 10-foot Cable, Vp Set to .30	B–3
Figure B–5: Flatline Display Out to 50,000+ Feet	B–4
Figure B–6: Waveform Off the Top of the Display	B–4
Figure B–7: Waveform at the Bottom of the Display	B–4
Figure B–8: Waveform with Gain at 57 dB	B–5
Figure B–9: Distance at –2.00 ft	B–7
Figure B–10: Pulse Adjusted to Four Major Divisions in Height	B–7
Figure B–11: Waveform Centered, Cursor at 10.00 ft	B–8
Figure B–12: Pulse Adjusted to Four Major Divisions in Height	B–8
Figure B–13: Aberrations Less Than Four Divisions Out to 30.00 ft	B–9
Figure B–14: Pulse Adjusted to Four Major Divisions in Height	B–9
Figure B–15: Aberrations Less Than Four Divisions Out to 300.00 ft	B–10
Figure B–16: Pulse Adjusted to Four Major Divisions in Height	B–10
Figure B–17: Aberrations Less Than Four Divisions Out to 3000.00 ft	B–11

List of Tables

Shipping Carton Test Strength	ix
Fuse and Voltage Ratings	1–2
Vp of Various Dielectric Types	1–10
Impedance of Various Cable Types	1–11
Suggested Pulse and Ft/Div for Cable Lengths	1–13
Option 06 Electrical Characteristics	3–16
Electrical Characteristics	A–1
Environmental Characteristics	A–3
Certifications and Compliances	A–4
Physical Characteristics	A–5

General Information

Product Description The Tektronix 1503C Metallic-cable Time-Domain Reflectometer (MTDR) is a cable test instrument that uses radar principles to determine the electrical characteristics of metallic cables.

The 1503C generates a half-sine wave signal, applies it to the cable under test, and detects and processes the reflected voltage waveform. These reflections are displayed in the 1503C liquid crystal display (LCD), where distance measurements may be made using a cursor technique. Impedance information may be obtained through interpreting waveform amplitude.

The waveform may be temporarily stored within the 1503C and recalled or may be printed using the optional dot matrix strip chart recorder, which installs into the front-panel Option Port.

Battery Pack The 1503C may be operated from an AC power source or an internal lead-acid battery that supply a minimum of five hours operating time (see the *Specifications* appendix for specifics).

Options Options available for the 1503C are explained in the *Options and Accessories* chapter of this manual.

Standards, Documents, and References Used Terminology used in this manual is in accordance with industry practice. Abbreviations are in accordance with ANSI Y1.1–1972, with exceptions and additions explained in parentheses in the text. Graphic symbology is based on ANSI Y32.2–1975. Logic symbology is based on ANSI Y32.14–1973 and manufacturer’s data books or sheets. A copy of ANSI standards may be obtained from the Institute of Electrical and Electronic Engineers, 345 47th Street, New York, NY 10017.

Changes and History Information Changes that involve manual corrections and/or additional data will be incorporated into the text and that page will show a revision date on the inside bottom edge. History information is included in any diagrams in gray.

Installation and Repacking

Unpacking and Initial Inspection

Before unpacking the 1503C from its shipping container or carton, inspect for signs of external damage. If the carton is damaged, notify the carrier. The shipping carton contains the basic instrument and its standard accessories. Refer to the replaceable parts list in the Service Manual for a complete listing.

If the contents of the shipping container are incomplete, if there is mechanical damage or defect, or if the instrument does not meet operational check requirements, contact your local Tektronix Field Office or representative. If the shipping container is damaged, notify the carrier as well as Tektronix.

The instrument was inspected both mechanically and electrically before shipment. It should be free of mechanical damage and meet or exceed all electrical specifications. Procedures to check operational performance are in the Performance Checks appendix. These checks should satisfy the requirements for most receiving or incoming inspections.

Power Source and Power Requirements

The 1503C is intended to be operated from a power source that will not apply more than 250 volts RMS between the supply conductors or between either supply conductor and ground. A protective ground connection, by way of the grounding conductor in the power cord, is essential for safe operation.

The AC power connector is a three-way polarized plug with the ground (earth) lead connected directly to the instrument frame to provide electrical shock protection. If the unit is connected to any other power source, the unit frame must be connected to earth ground.

Power and voltage requirements are printed on the back panel. The 1503C can be operated from either 115 VAC or 230 VAC nominal line voltage at 45 Hz to 440 Hz, or a battery pack.

Further information on the 1503C power requirements can be found in the Safety Summary in this section and in the Operating Instructions chapter.

Repacking for Shipment

When the 1503C is to be shipped to a Tektronix Service Center for service or repair, attach a tag showing the name and address of the owner, name of the individual at your firm who may be contacted, the complete serial number of the instrument, and a description of the service required. If the original packaging is unfit for use or is not available, repackage the instrument as follows:

1. Obtain a carton of corrugated cardboard having inside dimensions that are at least six inches greater than the equipment dimensions to allow for cushioning. The test strength of the shipping carton should be 275 pounds (102.5 kg). Refer to the following table for test strength requirements:

SHIPPING CARTON TEST STRENGTH	
Gross Weight (lb)	Carton Test Strength (lb)
0 – 10	200
11 – 30	275
31 – 120	375
121 – 140	500
141 – 160	600

2. Install the front cover on the 1503C and surround the instrument with polyethylene sheeting to protect the finish.
3. Cushion the instrument on all sides with packing material or urethane foam between the carton and the sides of the instrument.
4. Seal with shipping tape or an industrial stapler.

If you have any questions, contact your local Tektronix Field Office or representative.

Contacting Tektronix

Phone	1-800-833-9200*
Address	Tektronix, Inc. Department or name (if known) 14200 SW Karl Braun Drive P.O. Box 500 Beaverton, OR 97077 USA
Web site	www.tektronix.com
Sales support	1-800-833-9200, select option 1*
Service support	1-800-833-9200, select option 2*
Technical support	Email: support@tektronix.com 1-800-833-9200, select option 3* 1-503-627-2400 6:00 a.m. – 5:00 p.m. Pacific time

* This phone number is toll free in North America. After office hours, please leave a voice mail message.
Outside North America, contact a Tektronix sales office or distributor; see the Tektronix web site for a list of offices.

General Safety Summary

Review the following safety precautions to avoid injury and prevent damage to this product or any products connected to it. To avoid potential hazards, use this product only as specified.

Only qualified personnel should perform service procedures.

To Avoid Fire or Personal Injury

Use Proper Power Cord. Use only the power cord specified for this product and certified for the country of use.

Use Proper Voltage Setting. Before applying power, ensure that the line selector is in the proper position for the power source being used.

Power Source

This product is intended to operate from a power source that will not apply more than 250 volts RMS between the supply conductors or between the supply conductor and ground. A protective ground connection, by way of the grounding conductor in the power cord, is essential for safe operation.

Ground the Product. This product is grounded through the grounding conductor of the power cord. To avoid electric shock, the grounding conductor must be connected to earth ground. Before making connections to the input or output terminals of the product, ensure that the product is properly grounded.

The standard power cord (161-0288-00) is rated for outdoor use. *All other optional power cords are rated for indoor use only.*

Observe All Terminal Ratings. To avoid fire or shock hazard, observe all ratings and markings on the product. Consult the product manual for further ratings information before making connections to the product.

Do not apply a potential to any terminal, including the common terminal, that exceeds the maximum rating of that terminal.

Replace Batteries Properly. Replace batteries only with the proper type and rating specified.

Recharge Batteries Properly. Recharge batteries for the recommended charge cycle only.

Use Proper AC Adapter. Use only the AC adapter specified for this product.

Do Not Operate Without Covers. Do not operate this product with covers or panels removed.

Use Proper Fuse. Use only the fuse type and rating specified for this product.

Avoid Exposed Circuitry. Do not touch exposed connections and components when power is present.

Do Not Operate With Suspected Failures. If you suspect there is damage to this product, have it inspected by qualified service personnel.

Do Not Operate in an Explosive Atmosphere.

Symbols and Terms

Terms in this Manual. These terms may appear in this manual:



WARNING. Warning statements identify conditions or practices that could result in injury or loss of life.



CAUTION. Caution statements identify conditions or practices that could result in damage to this product or other property.

Terms on the Product. These terms may appear on the product:

DANGER indicates an injury hazard immediately accessible as you read the marking.

WARNING indicates an injury hazard not immediately accessible as you read the marking.

CAUTION indicates a hazard to property including the product.

Symbols on the Product. The following symbols may appear on the product:



Battery Recycling

This product contains a Nickel Cadmium (NiCd) battery, which must be recycled or disposed of properly. For the location of a local battery recycler in the U.S. or Canada, please contact:

RBRC
Rechargeable Battery Recycling Corp.
P.O. Box 141870
Gainesville, Florida 32614

(800) BATTERY
(800) 227-7379
www.rbrc.com

Operating Instructions

Overview

Handling The 1503C front panel is protected by a watertight cover, in which the standard accessories are stored. Secure the front cover by snapping the side latches outward. If the instrument is inadvertently left on, installing the front cover will turn off the POWER switch automatically.

The carrying handle rotates 325° and serves as a stand when positioned beneath the instrument.

The 1503C can be stored in temperatures ranging from -62° C to +85° C if a battery is not installed. If a battery is installed and the storage temperature is below -35° C or above +65° C, the battery pack should be removed and stored separately (see *1503C Service Manual* for instructions on removing the battery). Battery storage temperature should be between -35° C to +65° C.

Powering the 1503C In the field, the 1503C can be powered using the internal battery. For AC operation, check the rear panel for proper voltage setting. The voltage selector can be seen through the window of the protective cap. If the setting differs from the voltage available, it can be easily changed. Simply remove the protective cap and select the proper voltage using a screwdriver.

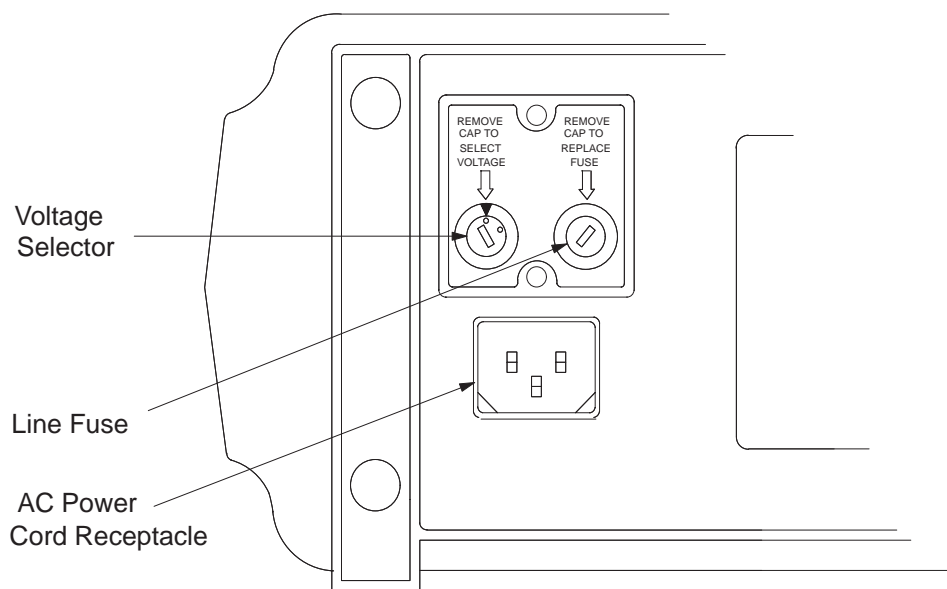

Figure 1-1: Rear Panel Voltage Selector, Fuse, AC Receptacle

The 1503C is intended to be operated from a power source that will not apply more than 250 V RMS between the supply conductors or between either supply conductor and ground. A protective ground connection by way of the grounding conductor in the power cord is essential for safe operation.

The AC power connector is a three-way polarized plug with the ground (earth) lead connected to the instrument frame to provide electrical shock protection. If the unit is connected to any other power source, the unit frame must be connected to an earth ground. See Safety and Installation section.



CAUTION. *If you change the voltage selector, you must change the line fuse to the appropriate value as listed near the fuse holder and in the table below.*

FUSE RATING	VOLTAGE RATING
250 V	NOMINAL RANGE
0.3 A T	115 VAC (90 – 132 VAC)
0.15 A T	230 VAC (180 – 250 VAC)

Care of the Battery Pack



CAUTION. *Read these instructions concerning the care of the battery pack. They contain instructions that reflect on your safety and the performance of the instrument.*

The 1503C can be powered by a rechargeable lead-gel battery pack that is accessible only by removing the case from the instrument. When AC power is applied, the battery pack is charged at a rate that is dependent on the battery charge state.

The battery pack will operate the 1503C for a minimum of eight continuous hours (including making 30 chart recordings) if the LCD backlight is turned off.

Battery Charging

The battery pack will charge fully in 16 hours when the instrument is connected, via the power cord, to an AC power source with the instrument turned off. The instrument may be turned on and operated while the batteries are charging, but this will increase the charging time. For longest battery life, a full charge is preferred over a partial charge.

For maximum capacity, the batteries should be charged within a temperature range of +20° C to +25° C. However, the batteries can be charged within a temperature range of 0° C to +40° C and operated in temperatures ranging from –10° C to +55° C.



CAUTION. Do not charge battery pack below 0° C or above +40° C. Do not discharge battery pack below -10° C or above +55° C. If removing the battery pack during or after exposure to these extreme conditions, turn the instrument off and remove the AC power cord.

The battery pack should be stored within a temperature range of -35° C to +65° C. However, the self-discharge rate will increase as the temperature increases.

If the instrument is stored with the battery pack installed, the battery pack should be charged every 90 days. A fully charged battery pack will lose about 12% of its capacity in three to four months if stored between +20° C and +25° C.

Low Battery

If the battery is low, it will be indicated on the LCD (bat/low). If this is the case, protective circuitry will shut down the 1503C within minutes. Either switch to AC power or work very fast. If the instrument is equipped with a chart recorder, using the recorder will further reduce the battery level, or the added load might shut down the instrument.

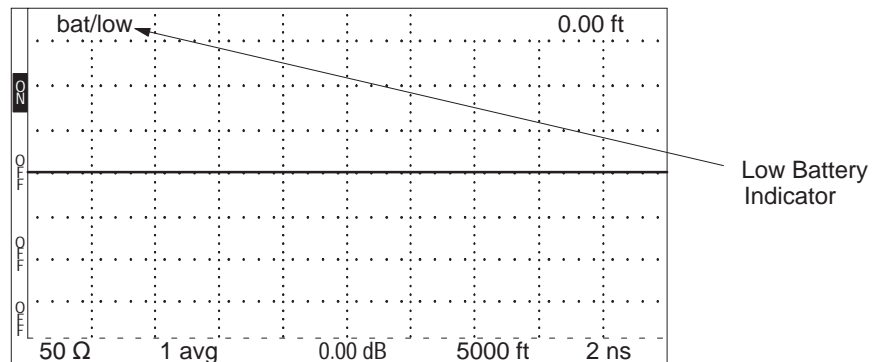

Figure 1-2: Display Showing Low Battery Indication

Protection circuits in the charger prevent deep discharge of the batteries during instrument operation. The circuits automatically shut down the instrument whenever battery voltage falls below approximately 10 V. If shutdown occurs, the batteries should be fully recharged before further use.

NOTE. Turn the POWER switch off after instrument shutdown to prevent continued discharge of the batteries.

Low Temperature Operation

When the instrument is stored at temperatures below -10° C, voids might develop in the liquid crystal display (LCD). These voids should disappear if the instrument is placed in an ambient temperature \geq +5° C for 24 hours.

When operating the 1503C in an environment below +10° C, a heater will activate. The element is built into the LCD module and will heat the display to permit normal operation. Depending on the surrounding temperature, it might take up to 15 minutes to completely warm the crystals in the LCD. Once warmed, the display will operate normally.

Preparing to Use the 1503C

Check the power requirements, remove the front cover, and you are ready to test cables. The following pages explain the front-panel controls.

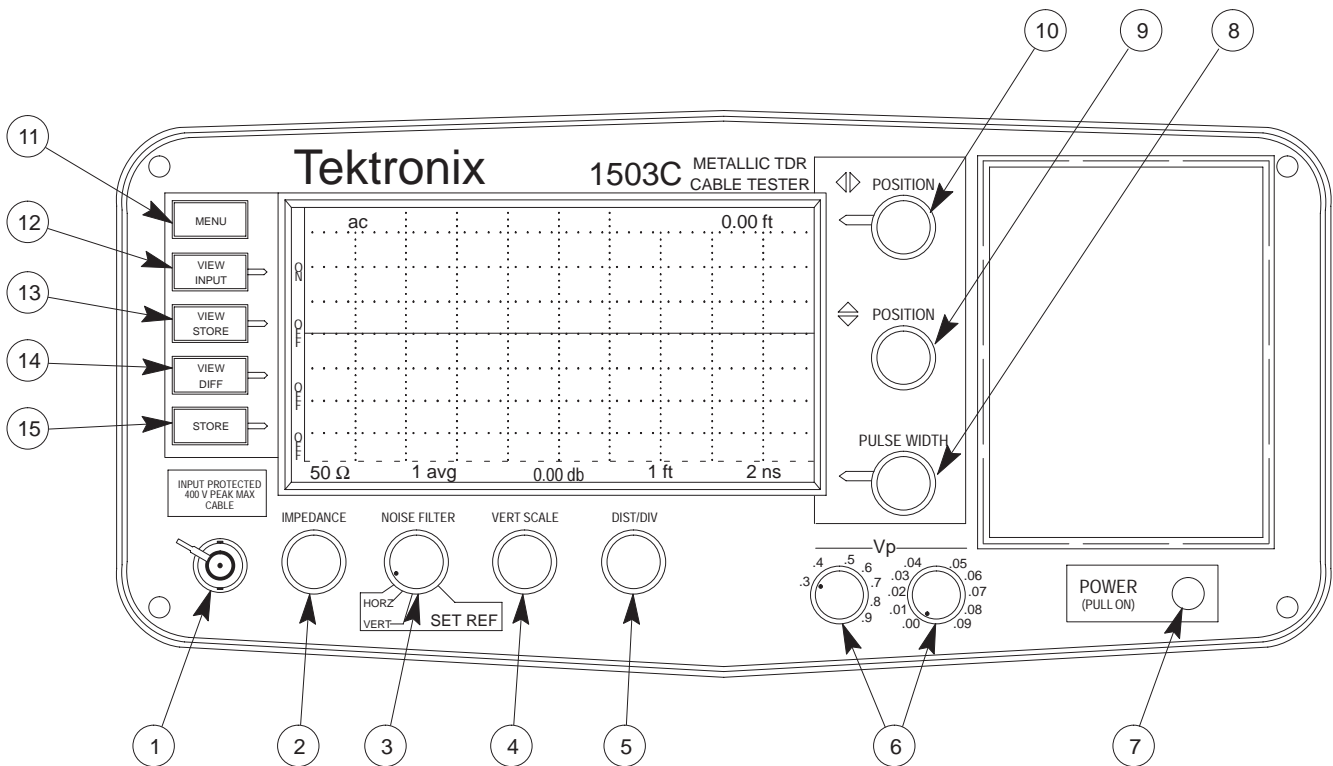

Figure 1-3: 1503C Front-Panel Controls



CAUTION. Do not connect to circuits or cables with live voltages greater than 400 V peak. Voltages exceeding 400 V might damage the 1503C front-end circuits.

Display

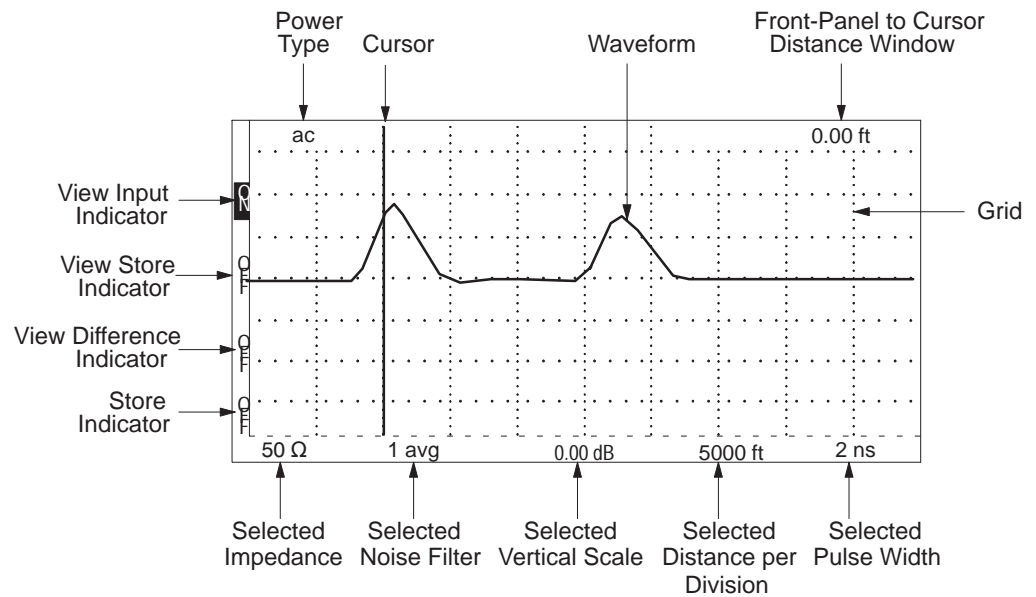
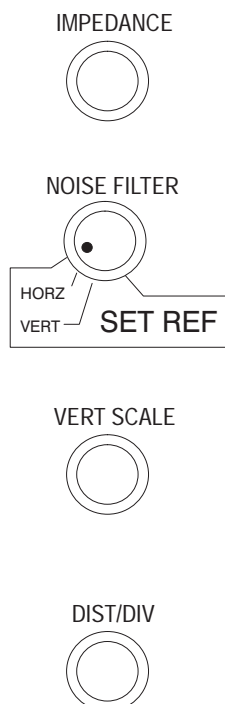

Figure 1-4: Display and Indicators

Front-Panel Controls



1. **CABLE:** A female BNC connector for attaching a cable to the 1503C for testing.
2. **IMPEDANCE:** A four-position rotary switch that selects the output impedance of the cable test signal. Available settings are 50, 75, 93, and 125 Ohms. The selected value is displayed above the control on the LCD.
3. **NOISE FILTER:** If the displayed waveform is noisy, the apparent noise can be reduced by using noise averaging. Averaging settings are between 1 and 128. The time for averaging is directly proportional to the averaging setting chosen. A setting of 128 might take the instrument up to 35 seconds to acquire and display a waveform. The first two positions on the NOISE FILTER control are used for setting the vertical and horizontal reference points. The selected value or function is displayed above the control on the LCD.
4. **VERT SCALE:** This control sets the vertical gain, displayed in dB, or the vertical sensitivity, displayed in m ρ per division. Although the instrument defaults to dB, you may choose the preferred mode from the *Setup Menu*. The selected value is displayed above the control on the LCD.
5. **DIST/DIV:** Determines the number of feet (or meters) per division across the display. The minimum setting is 1 ft/div (0.25 meters) and the maximum setting is 5000 ft/div (1000 meters). The selected value is displayed above the control on the LCD.

A standard instrument defaults to ft/div. A metric instrument (Option 05) defaults to m/div, but either may be changed temporarily from the menu. The default can be changed by changing an internal jumper (see *1503C Service Manual* and always refer such changes to qualified service personnel).

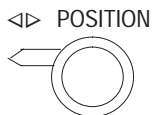
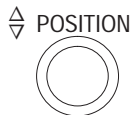
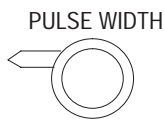
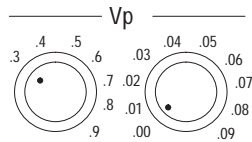

6. **Vp:** The two Velocity of Propagation controls are set according to the propagation velocity factor of the cable being tested. For example, solid polyethylene commonly has a Vp of 0.66. Solid polytetrafluorethylene (Teflon®) is approximately 0.70. Air is 0.99. The controls are decaded: the left control is the first digit and the right control is the second digit. For example, with a Vp of 0.30, the first knob would be set to .3 and the second knob to .00.
7. **POWER:** Pull for power ON and push in for power OFF. When the front cover is installed, this switch is automatically pushed OFF.
8. **PULSE WIDTH:** This is a five-position rotary switch that selects the pulse width of the cable test signal. The available settings are: 2, 10, 100, 1000 nanoseconds, and AUTO. The selected value is displayed on the LCD adjacent to the control. The AUTO setting sets the pulse width according to the distance registered at the right side of the LCD. The selected value is displayed to the left of this control on the LCD.
9. **POSITION:** This is a continuously rotating control that positions the displayed waveform vertically, up or down the LCD.
10. **POSITION:** This is a continuously rotating control that moves a vertical cursor completely across the LCD graticule. In addition, the waveform is also moved when the cursor reaches the extreme right or left side of the display. A readout (seven digits maximum) is displayed in the upper right corner of the LCD, showing the distance from the front panel BNC to the current cursor location.
11. **MENU:** This pushbutton provides access to the menus and selects items chosen from the menus.
12. **VIEW INPUT:** When pushed momentarily, this button toggles the display of the waveform acquired at the CABLE connector. This function is useful to stop displaying a current waveform to avoid confusion when looking at a stored waveform. This function defaults to ON when the instrument is powered up.
13. **VIEW STORE:** When pushed momentarily, this button toggles the display of the stored waveform.
14. **VIEW DIFF:** When pushed momentarily, this button toggles the display of the current waveform minus the stored waveform and shows the difference between them.
15. **STORE:** When pushed momentarily, the waveform currently displayed will be stored in the instrument memory. If a waveform is already stored, pushing this

button will erase it. The settings of the stored waveform are available from the first level menu under *View Stored Waveform Settings*.

Menu Selections

There are several layers of menu, as explained below.

Main Menu

The Main Menu is entered by pushing the MENU button on the front panel.

1. **Return to Normal Operations** puts the instrument into normal operation mode.
2. **Help with Instrument Controls** explains the operation of each control. When a control or switch is adjusted or pushed, a brief explanation appears on the LCD.
3. **Cable Information** has these choices:
 - a. **Help with Cables** gives a brief explanation of cable parameters.
 - b. **Velocity of Propagation Values** displays a table of common dielectrics and their Vp values. These are nominal values. The manufacturer's listed specifications should be used whenever possible.
 - c. **Impedance Values** displays impedances of common cables. In some cases, these values have been rounded off. Manufacturer's specifications should be checked for precise values.
 - d. **Finding Unknown Vp Values** describes a procedure for finding an unknown Vp.
4. **Setup Menu** controls the manner in which the instrument obtains and displays its test results.
 - a. **Acquisition Control Menu** has these choices:
 - i. **Max Hold Is: On/Off.** Turn Max Hold on by pushing MENU then STORE. In this mode, waveforms are accumulated on the display. Max Hold can be deactivated by pushing STORE or the mode exited by using the Setup Menu.
 - ii. **Pulse Is: On/Off.** Turns the pulse generator off so the 1503C does not send out pulses.
 - iii. **Single Sweep Is: On/Off.** This function is much like a still camera; it will acquire one waveform and hold it.
 - b. **Vertical Scale Is: dB/mp.** This offers you a choice as to how the vertical gain of the instrument is displayed. You may choose decibels or millirho. When powered down, the instrument will default to decibels when powered back up.

- c. **Distance/Div Is: ft/m.** Offers you a choice of how the horizontal scale is displayed. You may choose from feet per division or meters per division. When powered up, the instrument will default to feet unless the internal jumper has been moved to the meters position. Instructions on changing this default are contained in the *1503C Service Manual*.
 - d. **Light Is: On/Off.** This control turns the electroluminescent backlight behind the LCD on or off.
5. **Diagnostics Menu** lists an extensive selection of diagnostics to test the operation of the instrument.

NOTE. The Diagnostics Menu is intended for instrument repair and calibration. Proper instrument setup is important for correct diagnostics results. Refer to the 1503C Service Manual for more information on diagnostics.

- a. **Service Diagnostics Menu** has these choices:
 - i. **Sampling Efficiency Diagnostic** displays a continuous efficiency diagnostic of the sampling circuits.
 - ii. **Noise Diagnostic** measures the internal RMS noise levels of the instrument.
 - iii. **Impedance Diagnostic** tests the output impedance circuits in the instrument.
 - iv. **Offset/Gain Diagnostic** reports out-of-tolerance steps in the programmable gain stage. This can help a service technician to quickly isolate the cause of waveform distortion problems.
 - v. **RAM/ROM Diagnostics Menu** performs tests on the RAM (Random Access Memory) and the ROM (Read Only Memory).
 - vi. **Timebase Is: Normal - Auto Correction / Diagnostic - No Correction.** When in *Normal - Auto Correction*, the instrument compensates for variations in temperature and voltage. This condition might not be desirable while calibrating the instrument. While in *Diagnostic - No Correction*, the circuits will not correct for these variations.
- b. **Front Panel Diagnostics** aids in testing the front panel.
- c. **LCD Diagnostics Menu** has these choices:
 - i. **LCD Alignment Diagnostic** generates a dot pattern of every other pixel on the LCD. These pixels can be alternated to test the LCD.
 - ii. **Response Time Diagnostic** generates alternate squares of dark and light, reversing their order. This tests the response time of the LCD and

can give an indication of the effectiveness of the LCD heater in a cold environment.

- iii. **LCD Drive Test Diagnostic** generates a moving vertical bar pattern across the LCD.
 - iv. **Contrast Adjust** allows you to adjust the contrast of the LCD. It generates an alternating four-pixel pattern. The nominal contrast is set internally. When in *Contrast Adjust* mode, VERT SCALE is used as the contrast adjustment control. This value ranges from 0 to 255 units and is used by the processor to evaluate and correct circuit variations caused by temperature changes in the environment.
- d. **Chart Diagnostics Menu** offers various tests for the optional chart recorder.
- i. **LCD Chart** allows adjusting the number of dots per segment and the number of prints (strikes) per segment.
 - ii. **Head Alignment Chart** generates a pattern to allow mechanical alignment of the optional chart recorder.
6. **View Stored Waveform Settings** displays the instrument settings for the stored waveform.
7. **Option Port Menu** contains three items. Two items allow configuration of the option port for communicating with devices other than the optional chart recorder and one item test the option port.
- a. **Option Port Diagnostic** creates a repeating pattern of signals at the option port to allow service technicians to verify that all signals are present and working correctly.
 - b. **Set Option Port Timing** allows adjustment of the data rate used to communicate with external devices. The timing rate between bytes can be set from about 0.05 to 12.8 milliseconds.
 - c. **Option Port Debugging Is Off/On.** Off is quiet, On is verbose. This chooses how detailed the error message reporting will be when communicating with an external device.

It is possible to connect the instrument to a computer through a parallel interface with a unique software driver. Because different computers vary widely in processing speed, the instrument must be able to adapt to differing data rates while communicating with those computers. With user-developed software drivers, the ability to obtain detailed error messages during the development can be very useful. For more information, contact your Tektronix Customer Service representatives. They have information describing the option port hardware and software protocol and custom development methods available.

The SP-232, a serial interface product, also allows for connection of the 1503C to other instrumentation, including computers, via the option port. SP-232 is an RS-232C-compatible interface. For more information, contact your Tektronix Customer Service Representative. They can provide you with additional details on the hardware and software protocol.

8. Display Contrast (Software Version 5.02 and above)

- a. Press the MENU button firmly once. If the display is very light or very dark, you might not be able to see a change in the contrast.
- b. Turn the VERTICAL SCALE knob slowly clockwise to darken the display or counterclockwise to lighten the display. If you turn the knob far enough, the contrast will wrap from the darkest to lightest value.
- c. When the screen is clearly readable, press the MENU button again to return to normal measurement operation. The new contrast value will remain in effect until the instrument is turned off.

Test Preparations

The Importance of Vp (Velocity of Propagation)

Vp is the speed of a signal down the cable given as a percentage of the speed of light in free space. It is sometimes expressed as a whole number (e.g., 66) or a percentage (e.g., 66%). On the 1503C, it is the percentage expressed as a decimal number (e.g., 66% = .66). If you do not know the velocity of propagation, you can get a general idea from the following table, or use the *Help with Cables* section of the *Cable Information* menu. You can also find the Vp with the procedure that follows using a cable sample.

NOTE. *If you do not know the Vp of your cable, it will not prevent you from finding a fault in your cable. However, if the Vp is set wrong, the distance readings will be affected.*

All Vp settings should be set for the cable under test, not the supplied jumper cable.

Vp of Various Dielectric Types

Dielectric	Probable Vp
Jelly Filled	.64
Polyethylene (PIC, PE, or SPE)	.66
PTFE (Teflon ®) or TFE	.70
Pulp Insulation	.72
Foam or Cellular PE (FPE)	.78
Semi-solid PE (SSPE)	.84
Air (helical spacers)	.98

Impedance of Various Cable Types

50 Ω	75 Ω	93 Ω	125 Ω
RG-4	RG-6/U	RG-7/U	RG-23/U
RG-8/U	RG-11/U	RG-22/U	RG-63/U
RG-9/U	RG-12/U	RG-62/U	RG-79/U
RG-58/U	RG-13/U	RG-71/U	RG-89/U
RG-62/U	RG-59/U	RG-111/U	Flat Lead
RG-81	RG-124/U	Twisted Pair	Twisted Pair
RG-93	RG-140/U		
RG-142B/U	RG-179/U		
RG-225/U	75 Ω Video		
RG-303B/U			
RG-316/U			
RG-393/U			
Vertebrae Helix			

Finding an Unknown Vp

1. Obtain a known length of cable of the exact type you wish to test. Attach the cable to the CABLE connector on the front panel.
2. Pull POWER on.
3. Turn the DIST/DIV to an appropriate setting (e.g., if trying to find the Vp of a three-foot cable, turn the DIST/DIV to 1 ft/div).
4. Turn the <D> POSITION control until the distance reading is the same as the known length of this cable.
5. Turn the Vp controls until the cursor is resting on the rising portion of the reflected pulse. The Vp controls of the instrument are now set to the Vp of the cable.

The following three illustrations show settings too low, too high, and correct for a sample three-foot cable.

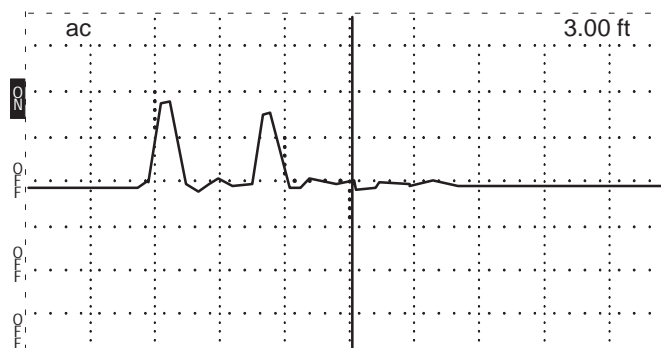

Figure 1-5: Vp Set at .30, Cursor Beyond Reflected Pulse (Setting Too Low)

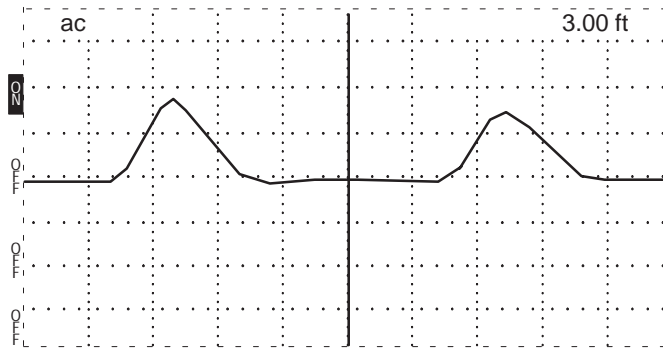

Figure 1-6: Vp Set at .99, Cursor Less Than Reflected Pulse (Setting Too High)



Figure 1-7: Vp Set at .66, Cursor on Rising Edge of Reflected Pulse (Set Correctly)

Cable Test Procedure

Distance to the Fault Be sure to read the previous paragraphs on Vp.

1. Set the 1503C controls:

POWER	On
CABLE	Cable to BNC
IMPEDANCE	50 Ω
NOISE FILTER	1 avg
DIST/DIV	(see below)
Vp	(per cable)
PULSE WIDTH	(per cable)

2. If you know approximately how long the cable is, set the DIST/DIV appropriately (e.g., 20-ft cable would occupy four divisions on the LCD if 5 ft/div was used). The entire cable should be displayed.

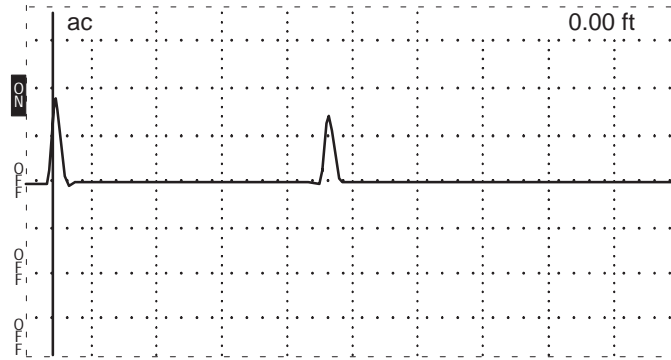

Figure 1-8: 20-ft Cable at 5 ft/div

If the cable length is unknown, set DIST/DIV to 5000 ft/div and continue to decrease the setting until the reflected pulse is visible. Depending on the cable length and the amount of pulse energy absorbed by the cable, it might be necessary to increase the VERT SCALE to provide more gain to see the reflected pulse.

The best pulse width is dependent on the cable length. A short pulse can be completely dissipated in a long cable. Increasing the pulse width will allow the reflected pulse to be more visible when testing long cables. AUTO will select the pulse width for you, depending on the distance on the right side of the LCD.

CABLE LENGTH	SUGGESTED PULSE	SUGGESTED ft/div
0 to 100 ft	2 ns	10 ft/div
51 to 500 ft	10 ns	50 ft/div
501 to 5000 ft	100 ns	500 ft/div
5001 to 50,000 ft	1000 ns	5000 ft/div

When the entire cable is displayed, you can tell if there is an open or a short. Essentially, a drop in the pulse is a short and a rise in the pulse is an open. Less catastrophic faults can be seen as hills and valleys in the waveform. Bends and kinks, frays, water, and interweaving all have distinctive signatures.

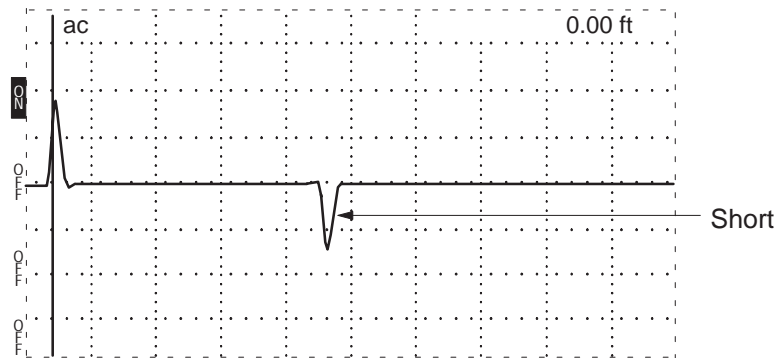

Figure 1-9: Short in the Cable

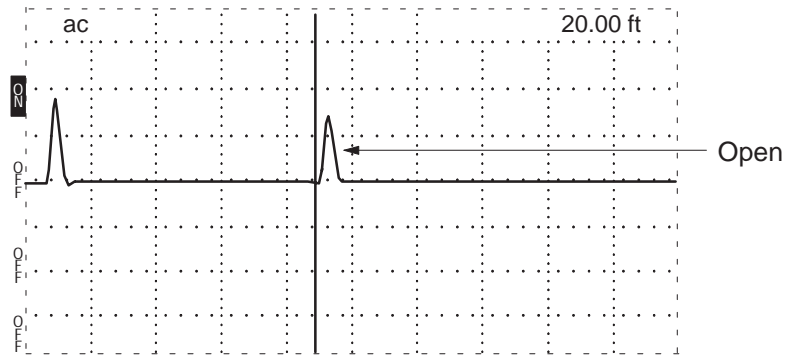

Figure 1-10: Open in the Cable

3. To find the distance to the fault or end of the cable, turn the $\langle \triangleright \rangle$ POSITION control until the cursor rests on the leading edge of the rising or falling reflected pulse (see Figure 1-10). Read the distance in the distance window in the upper right corner of the display.

A more thorough inspection might be required. This example uses a longer cable:

4. When inspecting a 455-foot cable, a setting of 100 ft/div allows a relatively fast inspection. If needed, turn VERT SCALE to increase the gain. The higher the gain, the smaller the faults that can be detected. If noise increases, increase the NOISE FILTER setting.

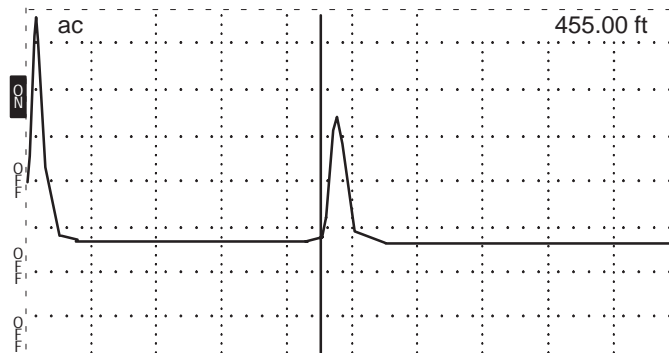

Figure 1-11: 455-ft Cable

5. Change DIST/DIV to 20 ft/div. The entire cable can now be inspected in detail on the LCD. Turn the $\langle \triangleright \rangle$ POSITION control so the cursor travels to the far right side of the LCD. Keep turning and the cable will be “dragged” across the display.

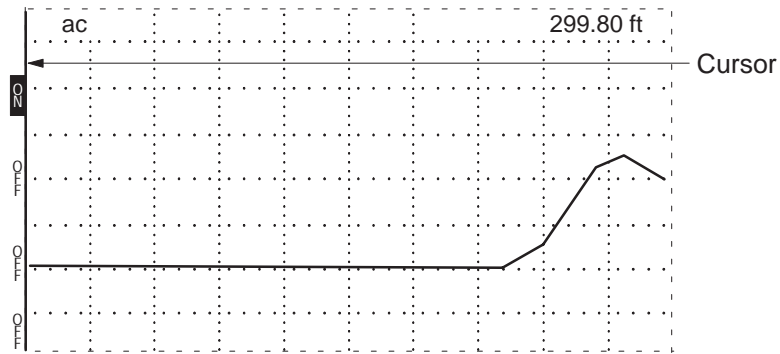

Figure 1-12: 455-ft Cable with 20 ft/div, Cursor Off Screen

A “rise” or “fall” is a signature of an impedance mismatch (fault). A dramatic rise in the pulse indicates an open. A dramatic lowering of the pulse indicates a short. Variations, such as inductive and capacitive effects on the cable, will appear as bumps and dips in the waveform. Capacitive faults appear as a lowering of the pulse (e.g., water in the cable). Inductive faults appear as a rising of the pulse (e.g., kinks in the cable). Whenever an abnormality is found, set the cursor at the beginning of the fault and read the distance to the fault on the distance window of the LCD.

Return Loss Measurements

Return loss is another way of measuring impedance changes in a cable. Mathematically, return loss is related to rho by the formula:

$$\text{Return Loss (in dB)} = -20 * \log (\text{base ten}) \text{ of Absolute Value of Rho } (V_{\text{ref}}/V_{\text{inc}})$$

To measure return loss with the 1503C, note the height of the incident pulse, then adjust the reflected pulse to be the same height that the incident pulse was and read the dB on the LCD display. The amount of vertical scale change that was needed is the return loss in dB.

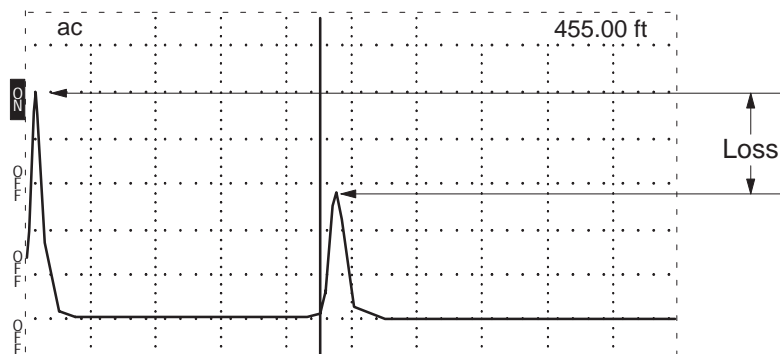

Figure 1-13: Return Loss

A large return loss means that most of the pulse energy was lost instead of being returned as a reflection. The lost energy might have been sent down the cable or absorbed by a terminator or load on the cable. A terminator matched to the cable

would absorb most of the pulse, so its return loss would be large. An open or short would reflect all the energy, so its return loss would be zero.

Reflection Coefficient Measurements

The 1503C can be made to display in $m\rho/\text{div}$ instead of dB through MENU.

1. Press MENU.
2. Select *Setup Menu*.
3. Press MENU.
4. Select *Vertical Scale is: Decibels*.
5. Press MENU. This changes the selection to *Vertical Scale is: Millirho*.
6. Press MENU again to exit from the Setup Menu.
7. Press MENU again to return to normal operation.

The reflection coefficient is a measure of the impedance change at a point in the cable. It is the ratio of the signal reflected back from a point divided by the signal going into that point. It is designated by the Greek letter ρ , and is written in this manual as Rho. The 1503C measures reflection coefficient in millirho (thousandths of a rho).

To measure a reflection, adjust VERT SCALE to make the reflection one division high. Read the reflection coefficient directly off the display above the VERT SCALE control. For reflections that are greater than 500 $m\rho/\text{div}$, adjust VERT SCALE for a reflection that is two divisions high and multiply the VERT SCALE reading by two.

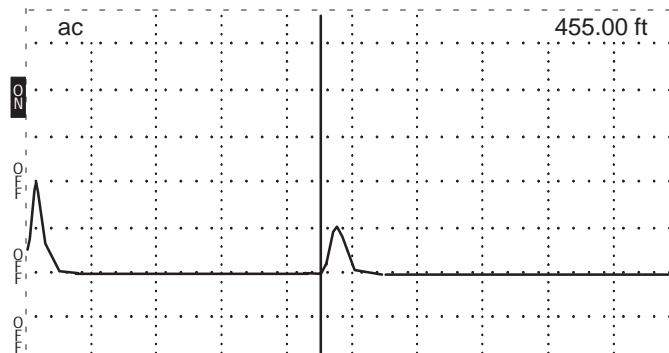

Figure 1-14: Reflection Adjusted to One Division in Height

In an ideal transmission system with no changes in impedance, there will be no reflections, so rho is equal to zero. A good cable that is terminated in its characteristic impedance is close to ideal and will appear as a flat line on the 1503C display.

Small impedance changes, like those from a connector, might have reflections from 10 to 100 mρ. If rho is positive, it indicates an impedance higher than that of the cable before the reflection. It will show as an upward shift or bump on the waveform. If rho is negative, it indicates an impedance lower than that of the cable prior to the reflection. It will show as a downward shift or dip on the waveform.

If the cable has an open or short, all the energy sent out by the 1503C will be reflected. This is a reflection coefficient of rho = 1, or +1000 mρ for the open and -1000 mρ for the short.

Effect of Cable Attenuation on Return Loss and Reflection Coefficient Measurements

Cable attenuation influences the return loss and reflection coefficient measurements made with the 1503C. If you desire to measure the return loss of only an impedance mismatch, the cable attenuation, as measured with an open or short circuit on the cable, must be subtracted from the directly measured value.

For reflection coefficient, the directly measured value of rho must be divided by the value measured with an open or short circuit on the cable. These calculations can be done manually, or the instrument can perform them by proper use of the VERT SET REF function.

It is not possible to measure the cable under test with an open or short, sometimes another cable of similar type is available to use as a reference. Note that cable attenuation is strongly influenced by signal frequency and, therefore, will be different from one pulse width to another on the 1503C.

Using VIEW INPUT

When pushed, the VIEW INPUT button displays the input at the front panel CABLE connector. When VIEW INPUT is turned off and no other buttons are pushed, the display will not have a waveform on it (see Figure 1-15). The default condition when the instrument is powered up is to have VIEW INPUT on.

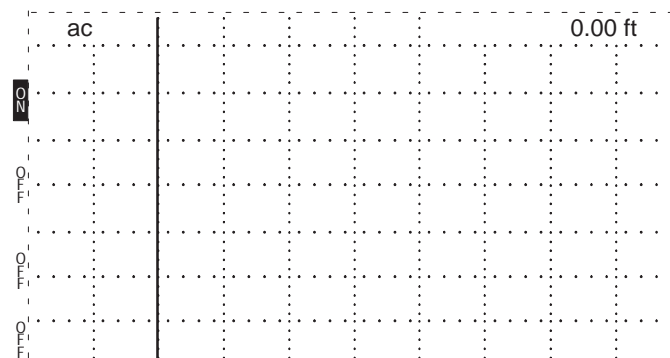

Figure 1-15: Display with VIEW INPUT Turned Off

How to Store the Waveform

When pushed, the STORE button puts the current waveform being displayed into memory. If already stored, pushing STORE again will erase the stored waveform.

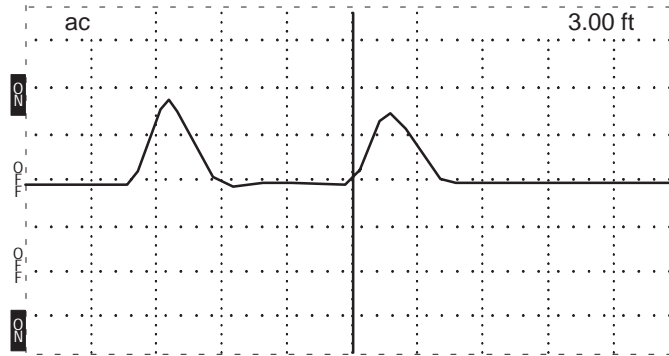

Figure 1-16: Display of a Stored Waveform

The front panel control settings and the menu-accessed settings are also stored. They are accessed under *View Stored Waveform Settings* in the first level of the menu.

Using VIEW STORE

The VIEW STORE button, when pushed on, displays the waveform stored in the memory as a dotted line. If there is no waveform in memory, a message appears on the LCD informing you of this.

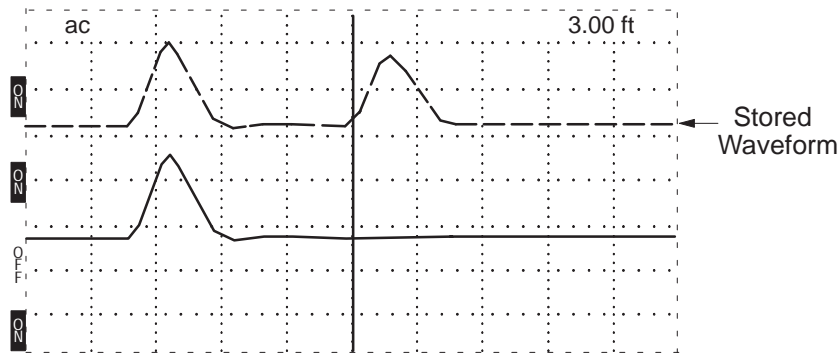

Figure 1-17: Display of a Stored Waveform and Current Waveform

Using VIEW DIFF

When pushed on, the VIEW DIFF button displays the difference between the current waveform and the stored waveform as a dotted line. If no waveform has been stored, a message will appear. The difference waveform is made by subtracting each point in the stored waveform from each point in the current waveform.

NOTE. If the two waveforms are identical (e.g., if STORE is pushed and VIEW DIFF is immediately pushed) the difference would be zero. Therefore you would see the difference waveform as a straight line.

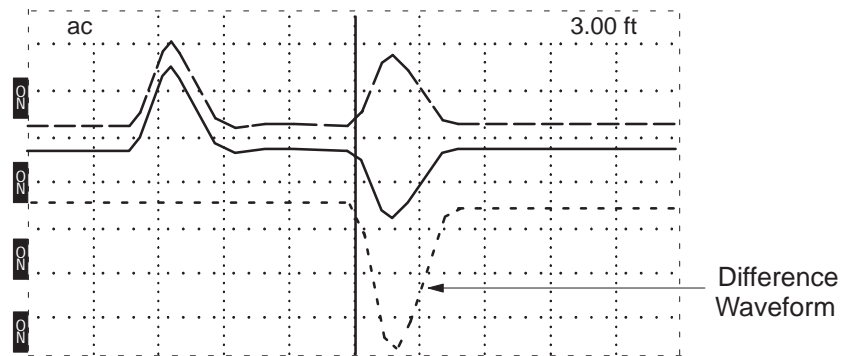

Figure 1-18: Display of a Stored Waveform, Current Waveform, and Difference Waveform

The VIEW DIFF waveform will move up and down with the current input as you move the Δ POSITION control. Any of the waveforms may be turned on or off independently. You might want to turn off some waveforms if the display becomes too busy or confusing.

NOTE. Because the stored waveform is not affected by changes in the instrument controls, care should be taken with current waveform settings or the results could be misleading.

One method to minimize the overlapping of the waveforms in VIEW DIFF is:

1. Move the waveform to be stored into the top half of the display.

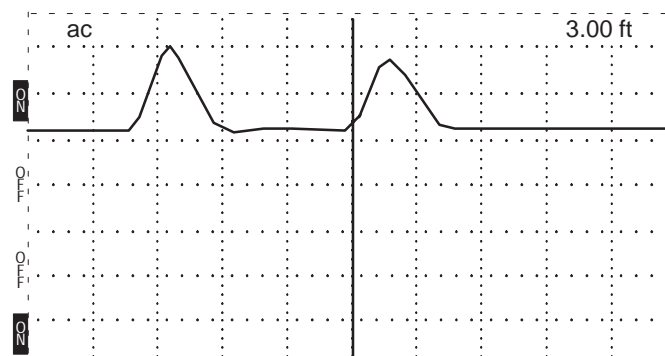

Figure 1-19: Waveform Moved to Top Half of Display

2. Push STORE to capture the waveform. Remember, once it is stored, this waveform cannot be moved on the display.
3. Move the current waveform (the one you want to compare against the stored waveform) to the center of the display.

4. Push VIEW STORE and the stored waveform will appear above the current waveform.

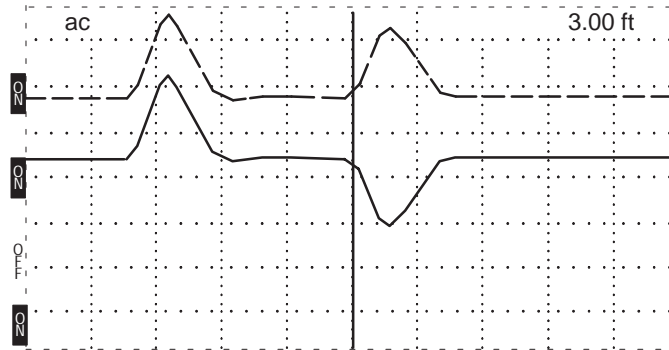

Figure 1-20: Current Waveform Centered, Stored Waveform Above

5. Push VIEW DIFF and the difference waveform will appear below the current waveform.

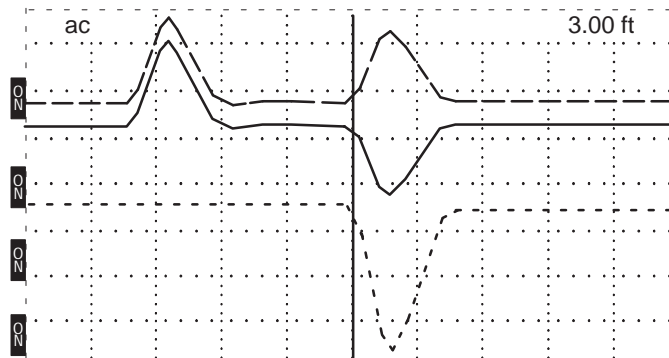

Figure 1-21: Current Waveform Center, Stored Waveform Above, Difference Below

Notice the VIEW INPUT waveform is solid, VIEW DIFF is dotted, and VIEW STORE is dot-dash.

There are many situations where the VIEW DIFF function can be useful. One common situation is to store the waveform of a suspect cable, repair the cable, then compare the two waveforms after the repair. During repairs, the VIEW INPUT, VIEW DIFF, and VIEW STORE waveforms can be used to judge the effectiveness of the repairs. The optional chart recorder can be used to make a chart of the three waveforms to document the repair.

Another valuable use for the VIEW DIFF function is for verifying cable integrity before and after servicing or periodic maintenance that requires moving or disconnecting the cable.

The VIEW DIFF function is useful when you want to see any changes in the cable. In some systems, there might be several reflections coming back from each branch of the network. It might become necessary to disconnect branch lines from the cable

under test to determine whether a waveform represents a physical fault or is simply an echo from one of the branches. The STORE and VIEW DIFF functions allow you to see and compare the network with and without branches.

Two important things to be observed when using the VIEW DIFF function:

- If you change either the VERT SCALE or DIST/DIV, you will no longer be comparing features that are the same distance apart or of the same magnitude on the display. It is possible to save a feature (e.g., a connector or tap) at one distance down the cable and compare it to a similar feature at a different distance by moving the \triangleleft POSITION and \triangle POSITION controls.
- When this is done, great care should be taken to make sure the vertical and horizontal scales are identical for the two waveforms being compared. If either the stored or current waveform is clipped at the top or bottom of the display, the difference waveform will be affected.

Using Horizontal Set Reference

HORZ SET REF (Δ mode) allows you to offset the distance reading. For example, a lead-in cable to a switching network is three feet long and you desire to start the measurement after the end of the lead-in cable. HORZ SET REF makes it simple.

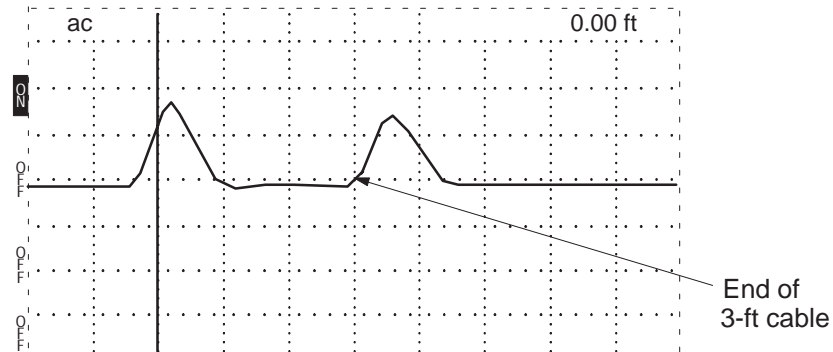

Figure 1-22: Waveform of Three-Foot Lead-in Cable

1. Turn the NOISE FILTER control to HORZ SET REF. The noise readout on the LCD will show: set Δ .
2. Turn the \triangleleft POSITION control to set the cursor where you want to start the distance reading. This will be the new zero reference point. For a three-foot lead-in cable, the cursor should be set at 3.00 ft.

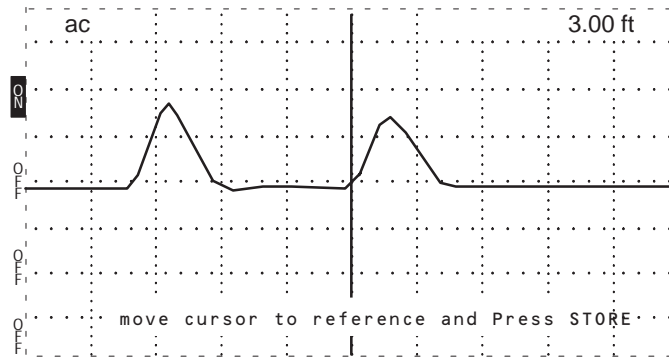

Figure 1-23: Cursor Moved to End of Three-Foot Lead-in Cable

3. Push STORE.
4. Turn the NOISE FILTER control to 1 avg. The instrument is now in HORZ SET REF, or delta mode. The distance window should now read 0.00 ft. As the cursor is scrolled down the cable, the distance reading will now be from the new zero reference point.

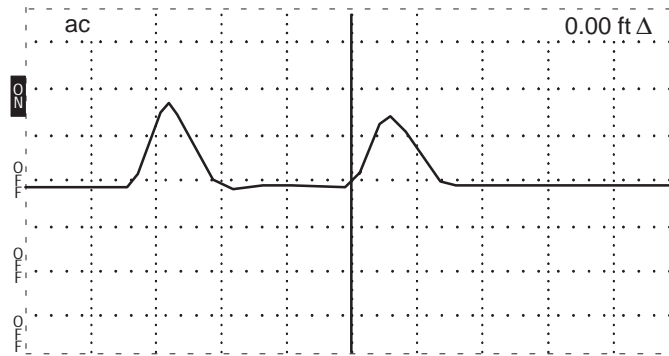

Figure 1-24: Cursor Moved to End of Three-Foot Lead-in Cable

NOTE. *V_p* changes will affect where the reference is set on the cable. Be sure to set the *V_p* first, then set the delta to the desired location.

5. To exit HORZ SET REF, use the following procedure:
 - a. Turn the NOISE FILTER control to HORZ SET REF.
 - b. Turn DIST/DIV to 1 ft/div. If the distance reading is extremely high, you might want to use a higher setting initially, then turn to 1 ft/div for the next adjustment.
 - c. Turn the <D>POSITION control until the distance window reads 0.00 ft.

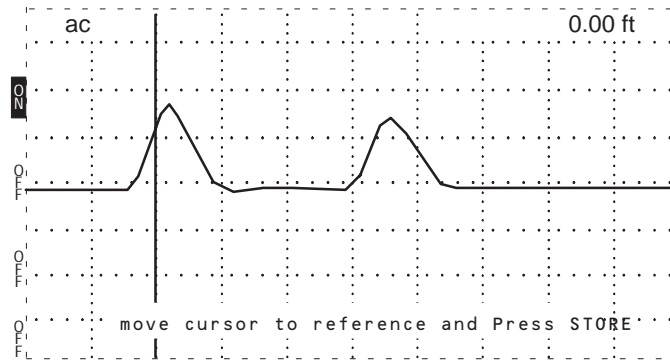

Figure 1-25: Cursor Moved to 0.00 ft

- d. Push STORE.
- e. Turn NOISE FILTER to desired setting.

Using Vertical Set Reference

VERT SET REF works similar to HORZ SET REF except that it sets a reference for gain (pulse height) instead of distance. This feature allows zeroing the dB scale at whatever pulse height is desired.

1. Turn NOISE FILTER fully counterclockwise. “Set Ref” will appear in the noise averaging area of the LCD.
2. Adjust the incident pulse to the desired height (e.g., four divisions). It might be necessary to adjust Δ POSITION.

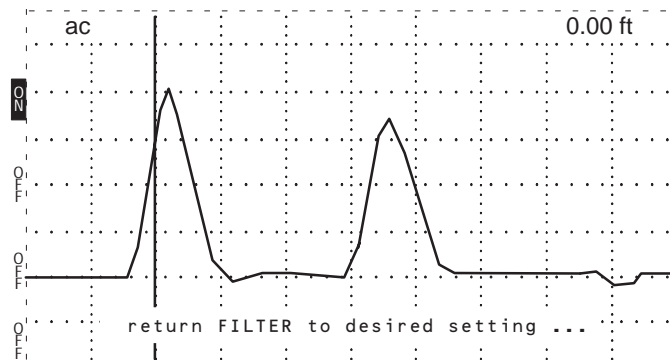

Figure 1-26: Incident Pulse at Four Divisions, FILTER at Desired Setting

3. Push STORE.
4. Return NOISE FILTER to the desired setting. Notice that the dB scale is now set to 0.00 dB.
5. To exit VERT SET REF, use the following procedure:
 - a. Make sure the vertical scale is in dB mode (access the Setup Menu if change is needed).

- b. Turn NOISE FILTER to VERT SET REF.
- c. Adjust VERT SCALE to obtain 0.00 dB.
- d. Push STORE.
- e. Turn NOISE FILTER to desire filter setting.

Because dB is actually a ratio between the energy sent out and the energy reflected back, using VERT SET REF does not affect the dB difference measured.

NOTE. Do not use Auto Pulse Width when making measurements in VERT SET REF. Auto Pulse Width changes the pulse width at 100, 500, and 5000 feet. If the pulse width changes while in VERT SET REF, it could result in an erroneous reading. Manually controlling the pulse width assures the pulse width remains the same for both the incident and reflective pulses.

Additional Features (Menu Selected)

Max Hold

The 1503C will capture and store waveforms on an ongoing basis. This is useful when the cable or wire is subjected to intermittent or periodic conditions. The 1503C will monitor the line and display any fluctuations on the LCD.

1. Attach the cable to the 1503C front-panel CABLE connector.
2. Push MENU to access the main menu.
3. Scroll to *Setup Menu* and push MENU again.
4. Scroll to *Acquisition Control Menu* and push MENU again.
5. Scroll to *Max Hold is: Off* and push MENU again. This line will change to *Max Hold is: On*. The monitoring function is now ready to activate.
6. Repeatedly push MENU until the instrument returns to normal operation.

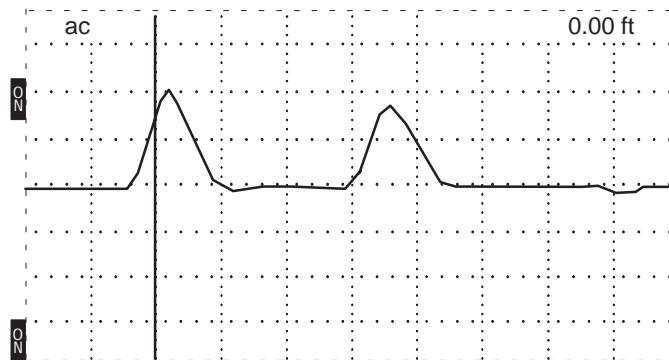

Figure 1-27: Waveform Viewed in Normal Operation

- When you are ready to monitor this cable for intermittents, push STORE. The 1503C will now capture any changes in the cable.

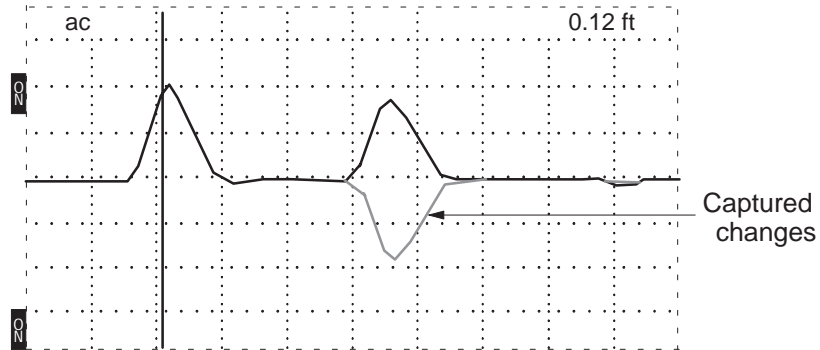

Figure 1-28: Waveform Showing Intermittent Short

- To exit monitor mode, push STORE again.
- To exit Max Hold, access the *Acquisition Control Menu* again, turn off Max Hold, and push MENU repeatedly until the instrument returns to normal operation.

Pulse On/Off

This feature puts the 1503C in a “listening mode” by turning off the pulse generator.

- Attach a cable to the 1503C front-panel CABLE connector.
- Push MENU to access the Main Menu.
- Scroll to *Setup Menu* and push MENU again.
- Scroll to *Acquisition Control Menu* and push MENU again.
- Scroll to *Pulse is: On* and push MENU again. This will change to *Pulse is: Off*.

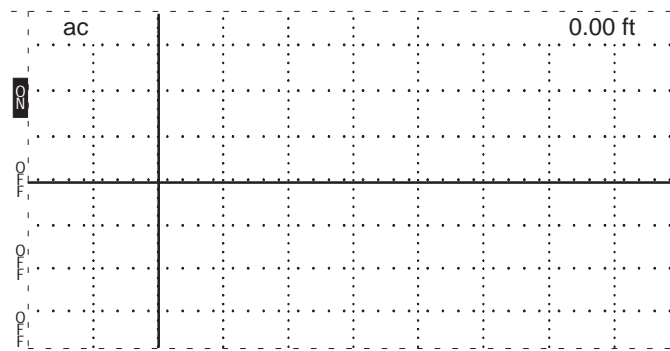

Figure 1-29: Waveform Display with No Outgoing Pulses

- Repeatedly press MENU until the instrument returns to normal operation.

This feature allows the 1503C to act much like a non-triggered oscilloscope. In this mode, the 1503C is acting as a detector only. Any pulses detected will not originate from the instrument, so any distance readings will be invalid. If you are listening to a local area network, for example, it is possible to detect traffic, but not possible to measure the distance to its origin.

Pulse is: Off can be used in conjunction with *Max Hold is: On*.

7. To exit *Pulse is: Off*, access the *Acquisition Control Menu* again, turn the pulse back on, then repeatedly push MENU until the instrument returns to normal operation.

Single Sweep

The single sweep function will acquire one waveform only and display it.

1. Attach a cable to the 1503C front-panel CABLE connector.
2. Push MENU to access the Main Menu.
3. Scroll to *Setup Menu* and push MENU again.
4. Scroll to *Acquisition Control Menu* and push MENU again.
5. Scroll to *Single Sweep is: Off* and push MENU again. This will change to *Single Sweep is: On*.
6. Repeatedly press MENU until the instrument returns to normal operation.
7. When you are ready to begin a sweep, push VIEW INPUT. A sweep will also be initiated when you change any of the front-panel controls. This allows you to observe front panel changes without exiting the Single Sweep mode.

As in normal operation, averaged waveforms will take longer to acquire.

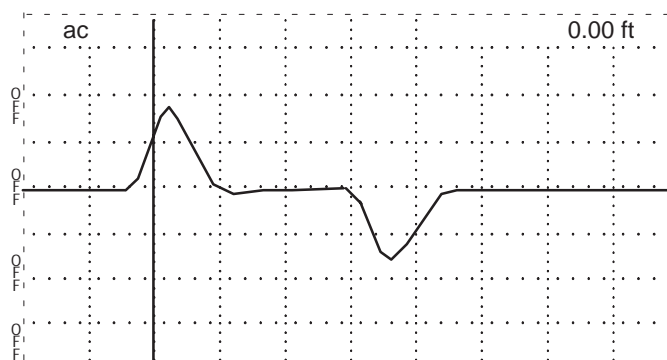

Figure 1-30: A Captured Single Sweep

8. To exit *Single Sweep is: On*, access the *Acquisition Control Menu* again, turn the Single Sweep back off, then repeatedly push MENU until the instrument returns to normal operation.

Operator Tutorial

This chapter will show, step by step, the features and uses of the 1503C.

What is the Tektronix 1503C?

The Tektronix 1503C Metallic Time-Domain Reflectometer is a long range metallic cable tester capable of finding faults in metal cable. Tests can be made on coaxial cable, twisted pair, or parallel cable.

How Does It Do It?

The 1503C sends an electrical pulse down the cable and receives reflections back made by any discontinuities. This is known as time-domain reflectometry. The 1503C is sensitive to impedance changes. Problems in the cable will be detected and displayed as changes in impedance along the cable. These will be displayed as hills and valleys in the reflected pulse. The 1503C is capable of finding shorts, opens, defects in the shield, foreign substances in the cable (e.g., water), kinks, and more. Even though other instruments might show a cable as good, the 1503C can show many previously hidden faults.

You, the Operator

The 1503C is a highly accurate cable tester. It is easy to use and will provide fast, accurate measurements. Because of electrical and environmental differences in cables and their applications, each waveform will likely differ. The best way to learn these differences is experience with the instrument. You are the 1503C's most important feature.

Experiment with different cables in known conditions and see how they compare. Subject cables to situations you might find in your application and learn the effects. We have included some examples of cable faults in this manual to help you gain familiarity. With practice, you will quickly become familiar with even the most subtle differences in waveforms.

Menus and Help

The 1503C is equipped with various help screens. Simply press MENU for assistance. The instrument will prompt you. More information on MENU is located in the *Operating Instructions* chapter of this manual.

Getting Started

Let's start by inspecting a cable. For the next few examples, we will use the 93 Ω 10-foot precision test cable provided with the 1503C (Tektronix part number 012-1351-00).

1. Pull on the POWER switch. The instrument will initialize, give instructions for accessing the menu, and enter normal operation mode.
2. Set the 1503C front-panel controls to:

CABLE	Attach 10-ft cable
IMPEDANCE	93 Ω
NOISE FILTER	1 avg
VERT SCALE	0.00 dB (default)
DIST/DIV	1 ft/div (0.25 m if using metric)
Vp	.84
PULSE WIDTH	2 ns

NOTE. *V_p (velocity of propagation) of the test cable is important for making accurate distance measurements. If you do not know the V_p factor of a cable, distance readings will be directly affected. You can get a general idea from the table on page 1–10 or find the V_p with a sample piece of cable using the procedure on page 1–10, or use the Cable Information Menu. If it is impossible to obtain the V_p of the cable, the instrument will still show cable faults, but the distance readings might be erroneous. The test cable used in this tutorial has a V_p of .84.*

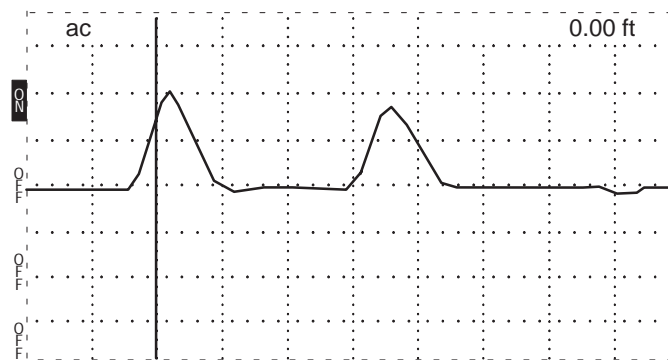

Figure 2-1: Display Showing 10-ft Cable in Start-Up Conditions

VERT SCALE will already be set to 0.00 dB (default). The cursor will be near the leading edge of the incident pulse (at the point on the waveform representing the front panel). Other information displayed includes the type of power used (ac or bat) and the distance window in the upper right corner of the LCD displays the distance from the front panel to the cursor (0.00 ft in this case). This data will be displayed when the instrument is turned on. Switch status and other instrument functions are also displayed (see Figure 1–4 on page 1–5 for descriptions).

- The pulse on the left is the test pulse (incident pulse) leaving the instrument. The reflected pulse on the right displays the echo coming back. Turn the \triangleleft POSITION control clockwise until the cursor rests on the rising edge of the reflected pulse.

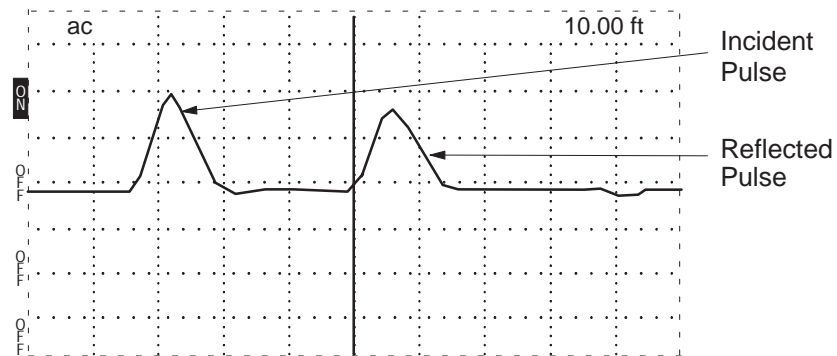

Figure 2-2: Cursor of Rising Edge of Reflected Pulse

The upper right corner should read 10.00 ft. Note that the reflected pulse rises. This is the classic signature of an open cable, a point of higher impedance.

- Adjust the VERT SCALE control. This will increase the height of the pulse. For accurate measurements, the pulse should occupy most of the display. Note that the LCD shows the VERT SCALE setting in dB. For now, set this control to 7 dB.

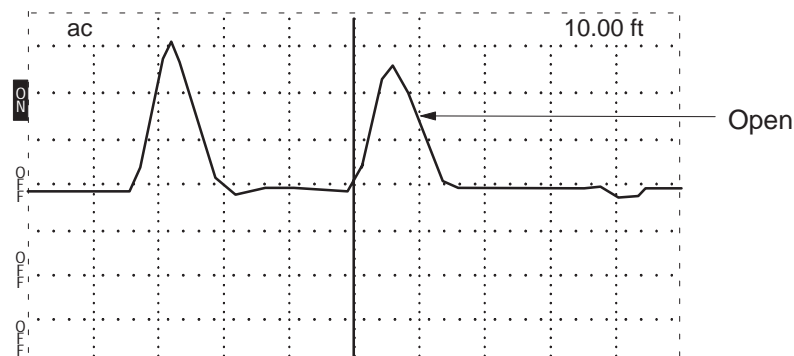

Figure 2-3: Waveform with VERT SCALE Increased Showing an Open

- The \triangleleft POSITION control moves the waveform up and down the display. Adjust this for best viewing.
- Short the end of the cable with an electrical clip or other suitable device. See the pulse take a dive? That is the classic signature of a short, a point of lower impedance.

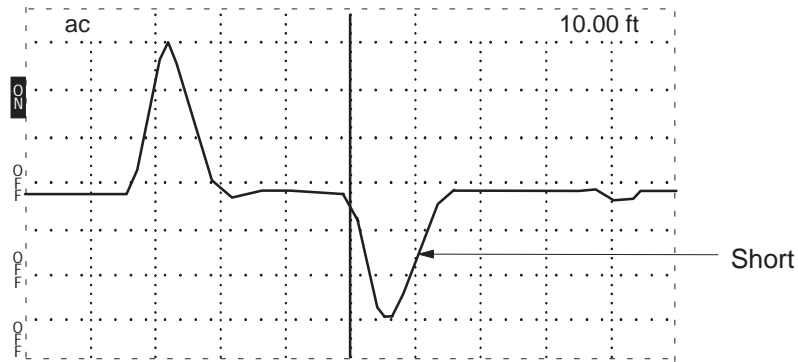

Figure 2-4: Waveform with Short

The distance window still reads 10.00 ft. If the short is not directly across the conductors of the BNC (e.g., needle nose pliers) the downward edge of the waveform might be slightly past the cursor, indicating the length of the shorting device (e.g., jumper wire).

7. Remove the short.

With a little practice, you will be able to identify many kinds of cable faults.

The Waveform Up Close

It helps to know what makes up a pulse. Here is the waveform anatomy using the 93 Ω 10-foot test cable as an example:

1. Turn the \triangleleft POSITION control counterclockwise until the distance window reads -2.00 ft. The cursor will be on the far left side of the display and the reflected pulse will be near center.

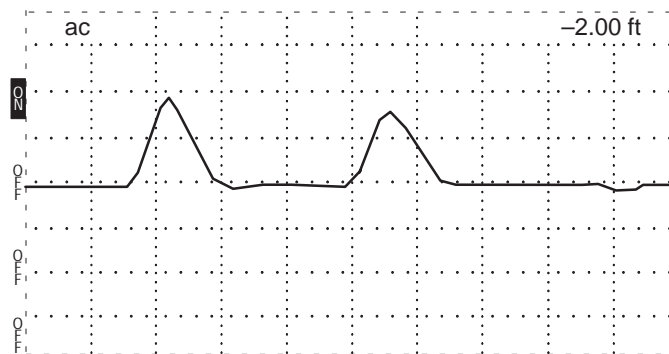

Figure 2-5: 10-foot Cable with Cursor at Far Left

- Set the 1503C front-panel controls:

CABLE	10-ft test cable, no short
IMPEDANCE	93 Ω
NOISE FILTER	1 avg
VERT SCALE	0.00 dB
DIST/DIV	1 ft (0.25 m)
V _p	.84
PULSE WIDTH	2 ns

- The first (left) pulse is the incident pulse, as sent from the pulse generator (see Figure 2-2). The second bump is the reflected pulse, as it bounces back from the end of the cable. The reflected pulse and the time between pulses provides the information needed for calculating the distance between faults or the end of the cable.
- Adjust the \triangleleft POSITION control so the cursor is at the beginning of the rise of the incident pulse. Note the distance window reads approximately -0.40 ft. This is the distance from the front panel BNC connector to the pulse generator circuit board inside the instrument (where the test pulse is generated).

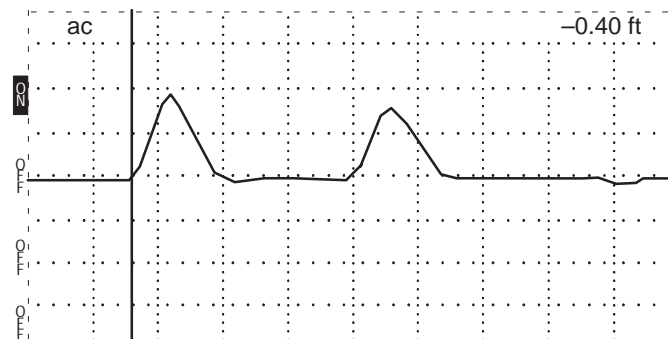

Figure 2-6: 10-foot Cable with Cursor at Incident Pulse

- Adjust the VERT SCALE control to approximately 25 dB. Adjust the \triangleleft POSITION control to keep the middle portion of the pulse on the display. The bumps following the incident pulse are the aberrations from the internal circuitry and reflections between the open end of the cable and the front panel.

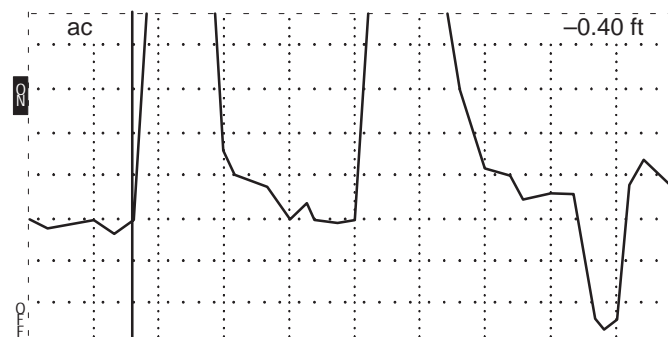

Figure 2-7: 10-foot Cable with Cursor at Incident Pulse, Vertical Scale at 25 dB

A Longer Cable

Longer cables might not fit in the display. Let's demonstrate that with a longer cable.

Obtain a known length of cable, preferably 50 Ω . For this example, we are using a coaxial cable approximately 455 feet long. Your cable length will probably differ, but the following test procedure remains fundamentally correct for any cable length up to 50,000 feet.

1. Set the 1503C front-panel controls:

CABLE	available longer cable
IMPEDANCE	50 Ω
NOISE FILTER	1 avg
VERT SCALE	10 dB
DIST/DIV	100 ft (25 m)
Vp	appropriate setting for your cable
PULSE WIDTH	Auto (clockwise)

2. With these settings, we can view the entire cable. By placing the cursor at the rise of the reflected pulse, we can see this particular cable is 456.00 ft.

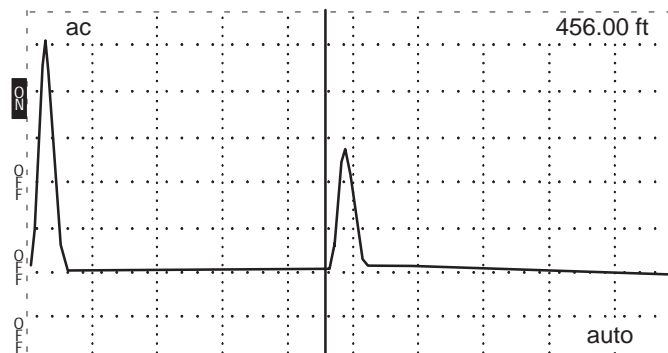

Figure 2-8: Cursor on End of Longer Cable

3. By decreasing the DIST/DIV control, the cable can be more closely inspected at the point of the cursor. Decrease the DIST/DIV to 10 ft/div. This has expanded the cable across the display.
4. Turn the $\langle \triangleright \rangle$ POSITION control counterclockwise. Note that the distance window changes as you scroll down the cable. In reality, you are electrically inspecting the cable, foot by foot.

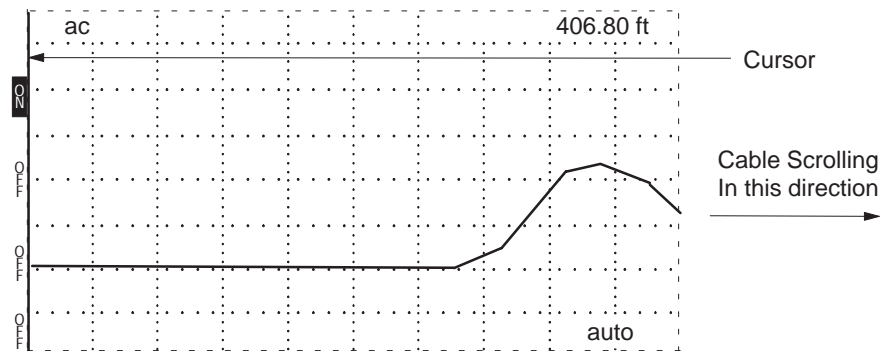

Figure 2-9: Scrolling Down the Cable

NOTE. When testing a long cable, it is helpful to set *DIST/DIV* to a higher setting when scrolling to either end of the cable. For example, if testing a 5,000-ft cable, it would be very tiring to scroll the entire length from end to end at 1 ft/div.

5. Turn the $\langle \triangleright \rangle$ POSITION control to return the cursor to the rise of the reflected pulse.
6. Increase *DIST/DIV* to 100 ft/div.
7. Set *PULSE WIDTH* to 2 ns. Notice that the pulse has nearly disappeared. Nearly all of the electrical energy set through the cable is absorbed.

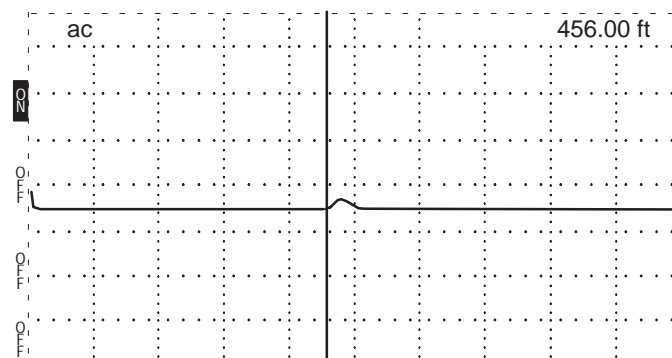

Figure 2-10: Pulse Width at 2 ns

8. Set *PULSE WIDTH* to 10 ns. The pulse height increases because there is more energy being sent through the cable.

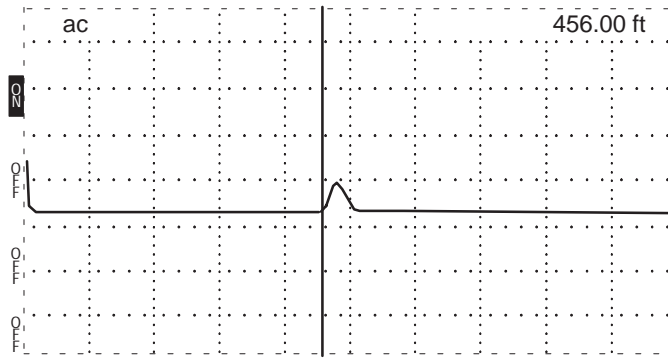

Figure 2-11: Pulse Width at 10 ns

9. Set PULSE WIDTH to 100 ns. Now the pulse is even larger and quite easy to see.

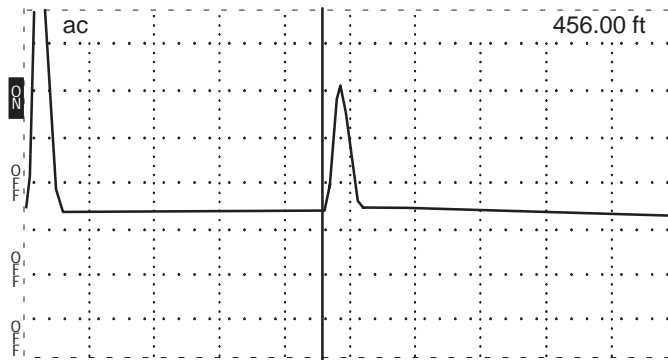

Figure 2-12: Pulse Width at 100 ns

10. Set PULSE WIDTH to 1000 ns. The pulse is now longer than the example cable. This would be a good pulse for a very long cable

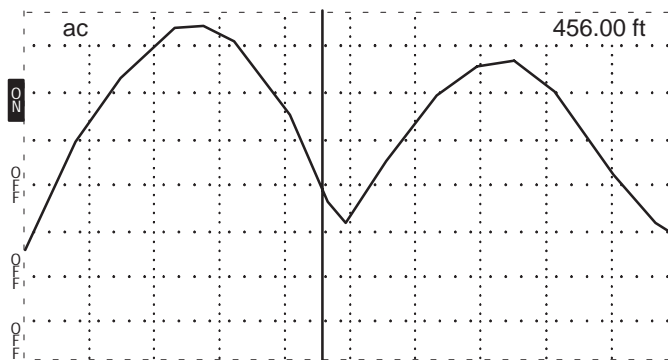

Figure 2-13: Pulse Width at 1000 ns, Longer than the Cable Being Tested

When the PULSE WIDTH control is set to Auto, the instrument automatically sets the pulse width in relation to the distance on the right side of the display. The following table shows the relationship between the distance on the display and the Auto pulse width.

CABLE LENGTH	SUGGESTED PULSE	SUGGESTED ft/div
0 to 100 ft	2 ns	10 ft/div
51 to 500 ft	10 ns	50 ft/div
501 to 5000 ft	100 ns	500 ft/div
5001 to 50,000 ft	1000 ns	5000 ft/div

Noise

On a longer cable, “grass” might appear on the displayed waveform. This is primarily caused by the cable acting as an antenna, picking up nearby electrical noise.

1. Set the 1503C front-panel controls:

CABLE	10-ft cable
IMPEDANCE	93 Ω
NOISE FILTER	1 avg
VERT SCALE	0.00 dB
DIST/DIV	1 ft (0.25 m)
Vp	.84
PULSE WIDTH	2 ns
<D>POSITION	50.0 ft

2. Attach the 50 Ω terminator to the end of the test cable using the female-to-female BNC adaptor (both of these items are supplied with the instrument).
3. Increase VERT SCALE to 50 dB. Use the Δ POSITION control to keep the waveform on the display. As the VERT SCALE setting increases, there will be noise in the form of a moving, fuzz-like waveform with a few random spikes.

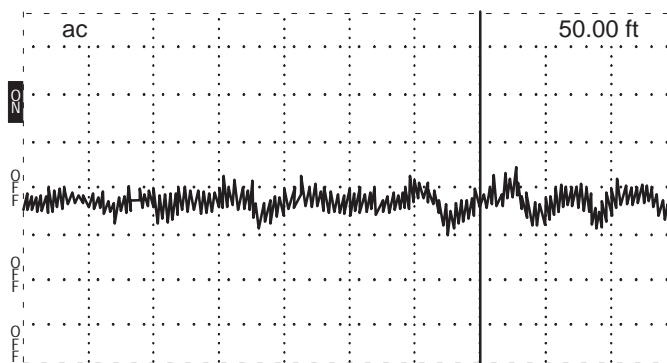

Figure 2-14: Noise on the Waveform.

4. Turn the NOISE FILTER control clockwise to 8. This will average out much of the noise.

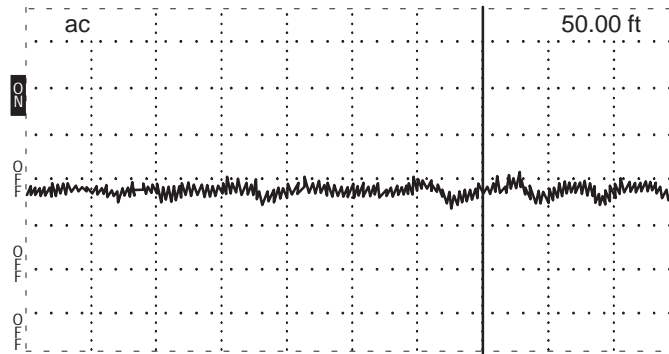

Figure 2-15: Noise Reduced.

5. Increase the NOISE FILTER setting to 128.

NOTE. The higher the setting, the more time the instrument takes to average the waveform.

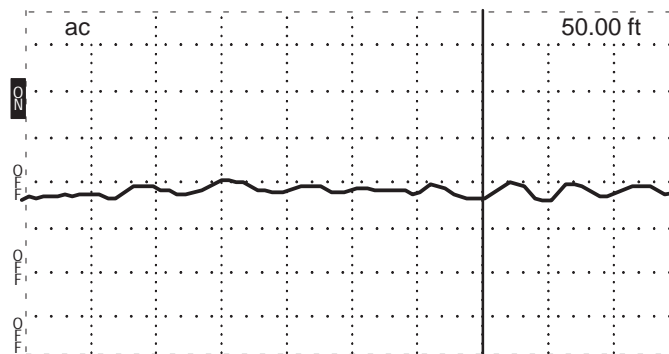

Figure 2-16: Noise Reduced to Minimum

6. Move the Δ POSITION control and notice how averaging restarts at a low value to allow easy positioning.

The 50 Ω terminator was used here because it gives a good impedance match. Because there are no large discontinuities, it appears to the instrument as an endless cable. The noise seen in this demonstration is noise picked up on the cable and a tiny amount of internal noise in the 1503C. When testing cables, the noise filter is extremely effective in reducing noise.

Set Ref (Δ Mode)

HORZ SET REF

Horizontal Set Reference establishes the starting point at which the distance window begins reading the distance to the cursor. If, for example, you have a 10-foot cable leading to a patch panel, you could eliminate this jumper from your distance readings.

1. Set the 1503C front-panel controls to:

CABLE	Attach 10-ft cable
IMPEDANCE	93 Ω
NOISE FILTER	1 avg
VERT SCALE	0.00 dB (default)
DIST/DIV	1 ft/div (0.25 m)
PULSE WIDTH	2 ns (no terminator)

NOTE. If the **POWER** was left on from the previous step, return the distance window reading to 0.00 ft with the \triangleleft **POSITION** control.

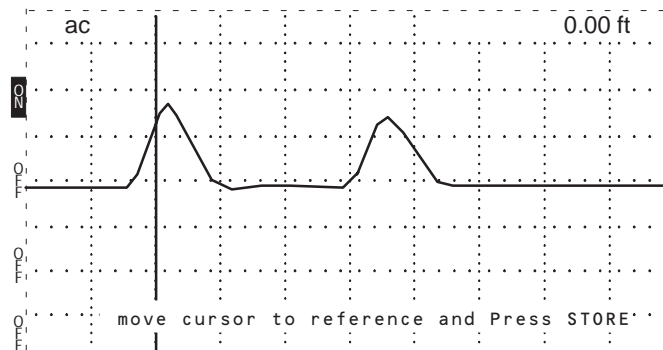

Figure 2-17: Incident and Reflected Pulses with Cursor at 0.00 ft

2. Turn the **NOISE FILTER** control counterclockwise to **HORZ SET REF**. The noise filter reading on the LCD will indicate *set Δ* .
3. Adjust the \triangleleft **POSITION** control so the cursor is on the rising edge of the reflected pulse. In this case, the distance window should read 10.0 ft.

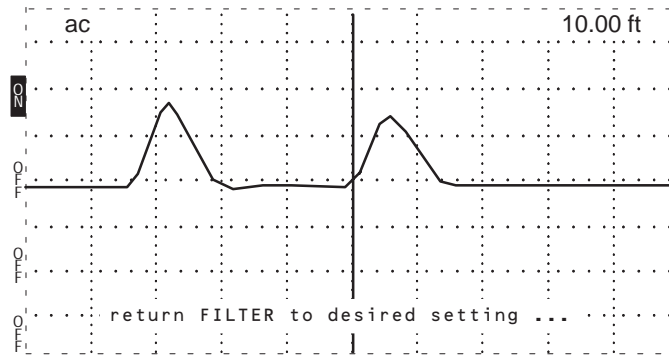

Figure 2-18: Incident and Reflected Pulses with Cursor at 10.0 ft

4. Press STORE.
5. Turn the NOISE FILTER control to 1 avg. Note that the distance window now reads 0.00 ft Δ . This means that everything from the front panel BNC to the end of the cable is subtracted from the distance calculations. You have set zero at the far end of the test cable.

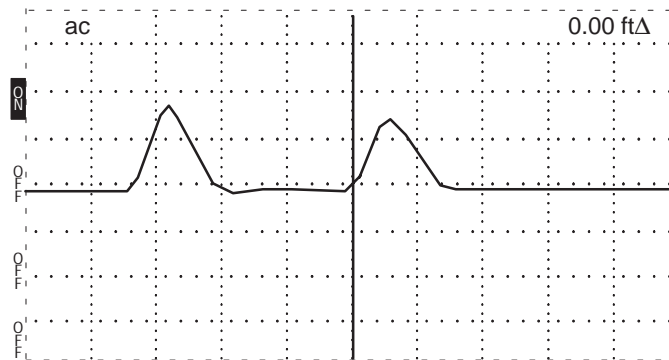

Figure 2-19: New Zero Set at End of Test Cable

6. To change the HORZ SET REF position, turn the NOISE FILTER back to HORZ SET REF and repeat the above procedure with a new cursor location.
7. To exit HORZ SET REF, do the following:
 - a. Set the \triangleleft POSITION control to exactly 0.00 ft (you might have to set DIST/DIV to 1 ft/div).
 - b. Push STORE.
 - c. Turn the NOISE FILTER control to the desired noise setting.

VERT SET REF

This control is nearly the same as HORZ SET REF except it sets the vertical zero reference. It would be helpful to read the section of VERT SET REF in the Operation Instructions chapter to give you some technical background.

The VERT SET REF function allows manual control of the vertical calibration of the 1503C. This can be used to compensate for cable loss or to increase the resolution of the return loss measurements. The following example shows how to compensate for cable loss.

The reflection from an open or a short at the far end of a long cable is often less than two divisions high at 0.00 dB. This is because of the energy lost in the cable before it gets to that fault. Here is how to correct for this loss and be able to make accurate measurements at the far end of the cable.

1. Connect the test cable.
2. Turn the NOISE FILTER all the way counterclockwise to VERT SET REF. A prompt will appear and the LCD will indicate *set ref.*

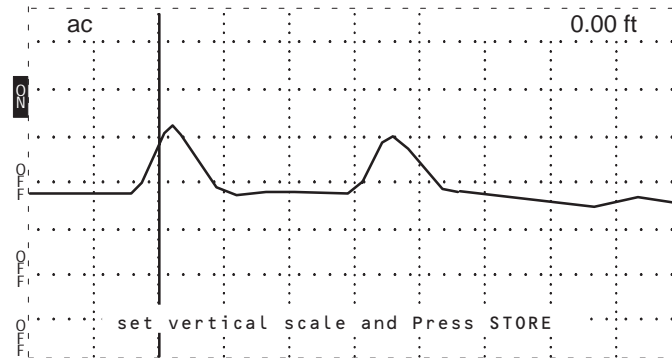

Figure 2-20: Display with 10-ft Cable and NOISE FILTER turned to VERT SET REF

3. Adjust the VERT SCALE control until the reflection from the open is two divisions high.

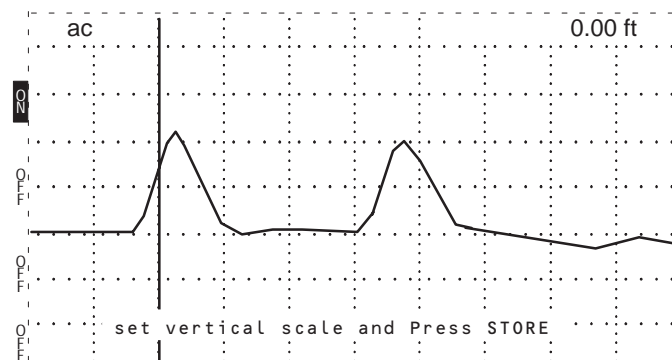

Figure 2-21: VERT SCALE adjusted to Make Pulse Two Divisions High

4. Push STORE and return NOISE FILTER to the desired setting.

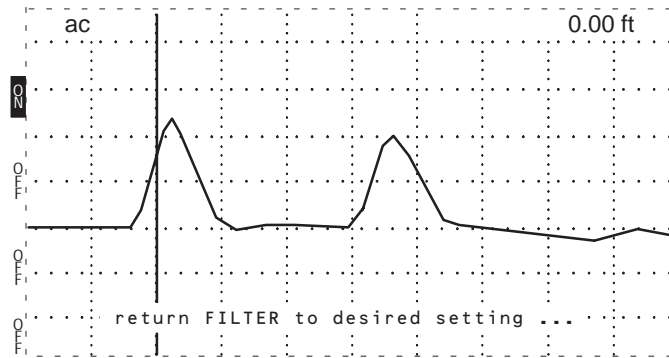

Figure 2-22: Filter Returned to Desired Setting

The vertical scale now reads 0.00 dB.

Return-loss measurements at the far end of the cable can now be made using normal methods. To make measurements closer or farther from the instrument requires that you reset the VERT SET REF.

5. To change the VERT SET REF, turn the noise filter back to VERT SET REF and repeat the preceding procedure.
6. If you wish to totally exit VERT SET REF, do the following:
 - a. Turn NOISE FILTER to VERT SET REF.
 - b. Turn VERT SCALE for a display reading of 0.00 dB (or 500 m ρ).
 - c. Push STORE.
 - d. Return the NOISE FILTER control to the desired setting.

VIEW INPUT

This push button allows you to view what is coming in the CABLE connector, or to eliminate it from the display.

1. Set the 1503C front-panel controls to:

CABLE	Attach 10-ft cable
IMPEDANCE	93 Ω
NOISE FILTER	1 avg
VERT SCALE	0.00 dB
DIST/DIV	1 ft/div (0.25 m)
PULSE WIDTH	2 ns

2. Press VIEW INPUT. The indicator block on the LCD should read OFF and the waveform should disappear from the display.



Figure 2-23: Display with VIEW INPUT Turned Off

3. Press VIEW INPUT again. The indicator block will reappear and the waveform should be displayed again.

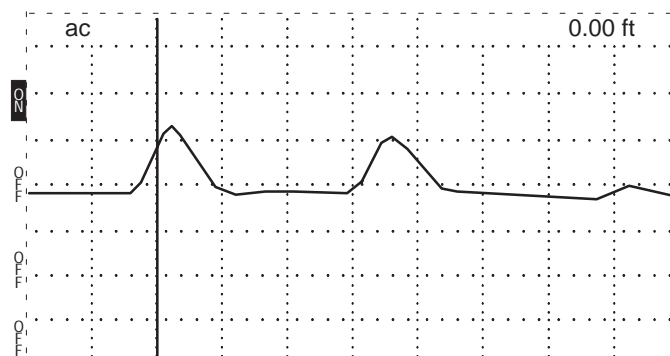

Figure 2-24: Display with VIEW INPUT Turned On

This function can be used to make the display less busy when viewing stored waveforms.

STORE and VIEW STORE

These functions allow you to store a waveform and view the stored waveform.

1. Set the 1503C front-panel controls to:

CABLE	Attach 10-ft cable
IMPEDANCE	93 Ω
NOISE FILTER	1 avg
VERT SCALE	0.00 dB
DIST/DIV	1 ft/div (0.25 m)
PULSE WIDTH	2 ns

2. Make sure you have a waveform on the LCD, then adjust the Δ POSITION control to place the waveform in the upper section of the display.

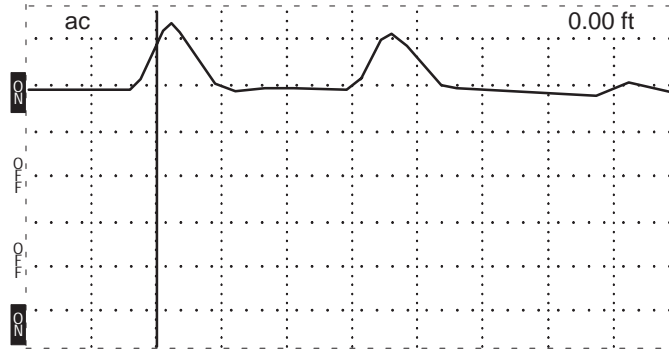

Figure 2-25: Waveform Moved to Upper Portion of the Display

3. Press STORE. The indicator block should become highlighted (black) and read ON. The waveform is now stored in non-volatile memory in the instrument.
4. Turn the POWER off for a few seconds, then turn it back on. Note that the STORE indicator block is ON, showing that there is a waveform in memory.
5. Short the connector at the far end of the test cable. The reflected pulse will invert from the previous open position. Adjust the Δ POSITION control to place the waveform in the middle portion of the LCD.

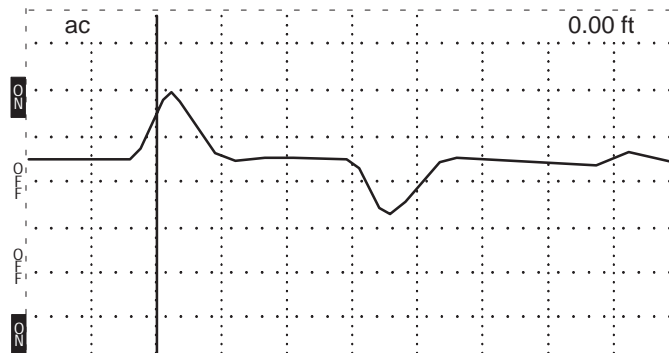

Figure 2-26: Waveform with Cable Shorted

6. Press VIEW STORE to view the stored waveform. What you see on the display is the waveform you stored previously with the open cable and the current waveform with the shorted cable.

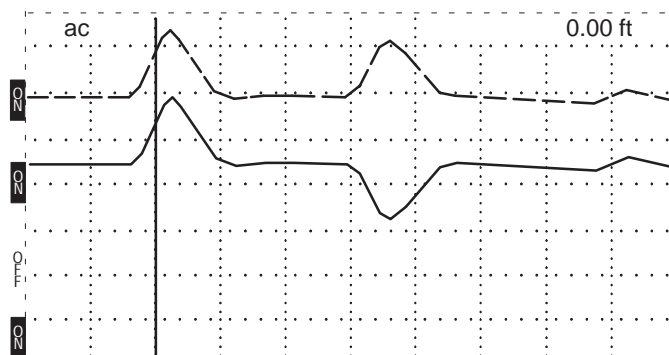

Figure 2-27: Waveform with Both Current and Stored Waveforms

Comparing new cables with old cables, or repaired cables with damaged cables is easy using these two pushbuttons.

Leave the instrument in this condition for the next lesson.

VIEW DIFF

Press VIEW DIFF. This adds a waveform in the lower portion of the display that is the mathematical difference between the stored waveform and the current waveform.

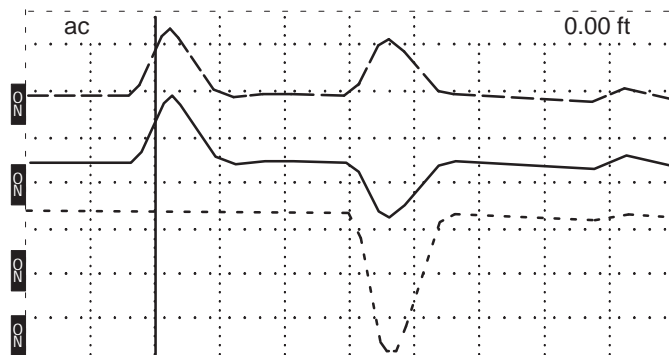

Figure 2-28: Stored, Current, and Difference Waveforms

NOTE. There must be a waveform stored before it can be compared by the VIEW DIFF function. Pressing this button with no waveform in storage will caused an error message to be displayed.

If the stored waveform and the current waveform are identical, the difference waveform will appear as a straight line.

Menu-Accessed Functions

NOTE. *If you get lost or confused while in a menu, repeatedly press the MENU button until the instrument returns to normal operation mode.*

Max Hold

1. Set the 1503C front-panel controls to:

CABLE	Attach 10-ft cable
IMPEDANCE	93 Ω
NOISE FILTER	1 avg
VERT SCALE	0.00 dB (default)
DIST/DIV	1 ft/div (0.25 m)
Vp	.84
PULSE WIDTH	2 ns

2. Pull POWER on.
3. Press MENU to access the Main Menu.
4. Using the ∇ POSITION control, scroll down to *Setup Menu*.
5. Press MENU to accept this selection.
6. Scroll down to *Acquisition Control Menu*.
7. Press MENU to accept this selection.
8. Scroll down to *Max Hold is: Off*.
9. Press MENU to toggle this selection. It should now read *Max Hold is: On*. The Max Hold function is now ready.
10. Read the instructions on the display and press MENU again.
11. Press MENU again to exit the Acquisition Control Menu.
12. Press MENU again to exit the Setup Menu.
13. Press MENU again to enter normal operations mode. Note that the VIEW STORE and VIEW DIFF indicator blocks have disappeared. This tells you that both of these functions have been disabled.

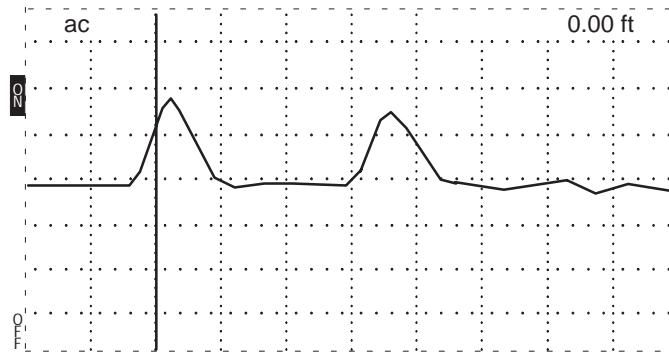

Figure 2-29: Display with VIEW STORE and VIEW DIFF Disabled.

14. Press STORE. This activates the Max Hold function. Notice that the STORE indicator block has darkened.
15. With a clip lead or other device, short the far end of the test cable, then remove the short. Note that both conditions now appear on the display.

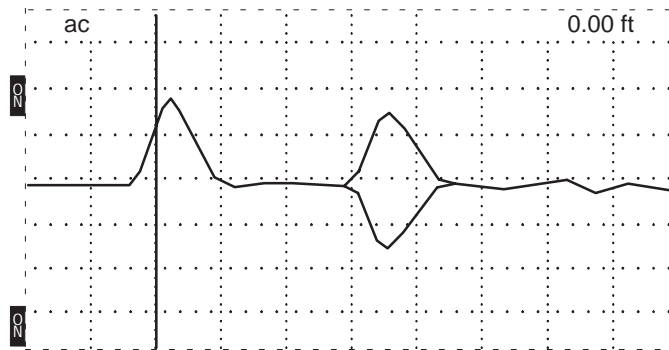

Figure 2-30: Short and Open Viewed via Max Hold

16. Turn the Δ POSITION control counterclockwise. The waveform will strobe down the display, leaving traces of its movement.

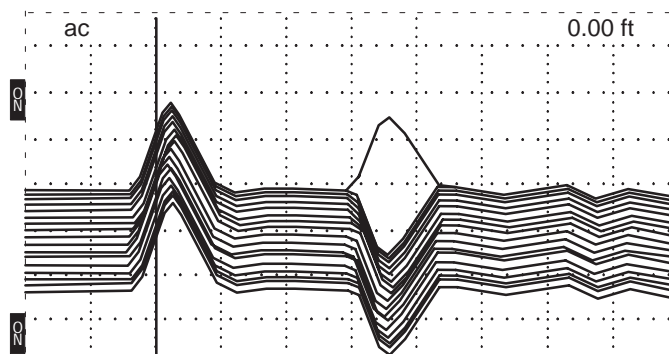

Figure 2-31: Waveform Strobed Down Display in Max Hold

17. Press STORE. The display will clear, awaiting STORE to be pressed again, which would activate another Max Hold monitor cycle.

You can probably see how this function is useful for monitoring lines for changes over a period of time, or for intermittent conditions. For example:

- A coastal phone line only has problems during high tide. Overnight monitoring reveals water in the line during the high tide period.
 - A data communications line is monitored for an intermittent short. Three days of monitoring reveals the shorts occur only during the hours of darkness. Rodents are found in the cable ducts.
 - A cable becomes defective only during daytime hours. Monitoring reveals the line length increases (sags) during the heat of the day, shorting out on a tree limb. During the night, the cable cools, tightens, and is no longer shorted on the tree limb.
18. To exit Max Hold, access the *Acquisition Control Menu* again, turn off Max Hold, and push MENU repeatedly until the instrument returns to normal operation.

Pulse On / Off

1. Set the 1503C front-panel controls to:

CABLE	Attach 10-ft cable
IMPEDANCE	93 Ω
NOISE FILTER	1 avg
VERT SCALE	0.00 dB (default)
DIST/DIV	1 ft/div (0.25 m)
V _p	.84
PULSE WIDTH	2 ns
2. Pull POWER on.
3. Press MENU to access the Main Menu.
4. Using the ∇ POSITION control, scroll down to *Setup Menu*.
5. Press MENU to accept this selection.
6. Scroll down to *Acquisition Control Menu*.
7. Press MENU to accept this selection.
8. Scroll down to *Pulse is: On*.
9. Press MENU to toggle this selection. It should now read *Pulse is: Off*.
10. Press MENU repeatedly until the instrument returns to normal operation.

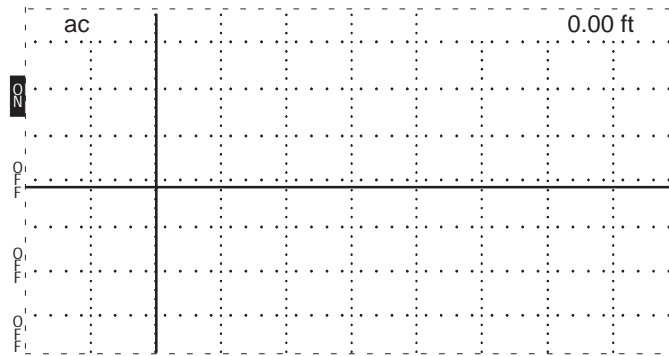

Figure 2-32: Display with Pulse Turned Off

Note that there is no pulse visible on the display. The 1503C is now functioning as a listening device, much like a non-triggered oscilloscope. Uses include monitoring the cable for pulses.

11. To turn the pulse back on, enter the *Acquisition Control Menu* again, scroll to *Pulse is: Off* and press MENU to turn the pulse back on. Repeatedly press MENU until the instrument returns to normal operation.

Single Sweep

1. Set the 1503C front-panel controls to:

CABLE	Attach 10-ft cable
IMPEDANCE	93 Ω
NOISE FILTER	1 avg
VERT SCALE	0.00 dB (default)
DIST/DIV	1 ft/div (0.25 m)
Vp	.84
PULSE WIDTH	2 ns

2. Pull POWER on.
3. Press MENU to access the Main Menu.
4. Using the \diamond POSITION control, scroll down to *Setup Menu*.
5. Press MENU to accept this selection.
6. Scroll down to *Acquisition Control Menu*.
7. Press MENU to accept this selection.
8. Scroll down to *Single Sweep is: Off*.
9. Press MENU to toggle this selection. It should now read *Single Sweep is: On*.
10. Press MENU repeatedly until the instrument returns to normal operation. The waveform on the display is the familiar test cable.

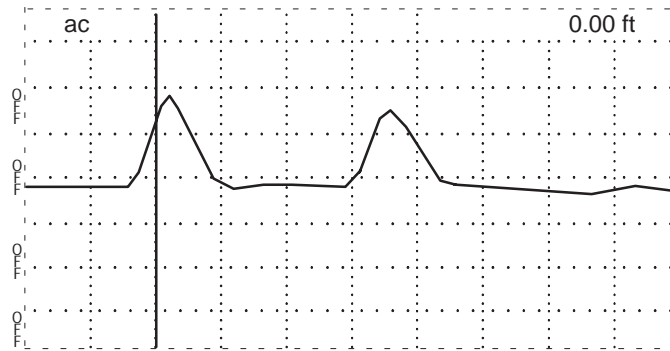

Figure 2-33: Test Cable

11. Short the far end of the test cable.
12. Press VIEW INPUT. The 1503C has done a single sweep, capturing just one frame.

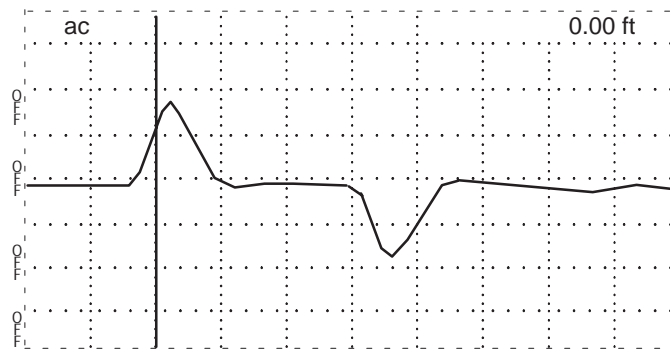

Figure 2-34: Shorted Test Cable with a Captured Single Sweep

13. Remove the short and notice that the waveform does not change.
14. Press VIEW INPUT again and a new sweep will be made and displayed, showing the change in the cable.

Single Sweep is useful for snap-shot tests of the cable, capturing only one waveform.

15. To exit Single Sweep, access the Acquisition Control Menu again, toggle the Single Sweep is: line back to Off, then push the MENU button repeatedly until the instrument returns to normal operations.

TDR Questions and Answers

Q1: *What does TDR stand for?*

A1: Time-Domain Reflectometer.

Q2: *What is the difference between time domain and frequency domain?*

A2: Within the time domain, things are expressed in units of time (e.g., nanoseconds). In frequency domain, things are expressed in frequency, cycles per second (e.g., kiloHertz).

Q3: *What does a TDR actually measure?*

A3: Voltage over time.

Q4: *How does a TDR display this information?*

A4: Voltage on the vertical axis (as amplitude of the waveform) and time on the horizontal axis (as distance to the event).

Q5: *Does electricity travel the same speed (velocity) in all materials?*

A5: No. Electricity is like light; its velocity is affected by the material through which it passes.

Q6: *What is that difference called?*

A6: The relative velocity of propagation (V_p). The velocity of the cable is expressed in time/distance (e.g., feet per nanosecond). The velocity of electricity traveling in a vacuum is compared to the velocity of electricity traveling in a cable. This relationship is shown as a decimal number. A relative propagation velocity of .50 would mean the electricity will travel at 50%, or one-half, as fast as it would in a vacuum.

Q7: *If a reflection takes 30 nanoseconds to return in a cable with a V_p of .66, how far away is the point on the cable that caused the reflection?*

A7: The one-way time would be 30 divided by 2, or 15 nanoseconds. The velocity of 1 ns/ft in a vacuum would mean a distance of 15 feet. Because the cable is slower, we multiply the distance by the V_p (.66 in this case) and arrive at a distance of 10 feet. Of course, the 1503C does all this automatically and displays the information on the LCD.

Q8: *What is resistance?*

A8: Resistance is the opposition to DC current flow, or DC voltage divided by DC current.

Q9: *What is impedance?*

A9: Impedance is the total opposition (resistance plus reactance) a circuit offers to the flow of alternating current at a given frequency.

Q10: *What factors determine the resistance of a cable?*

A10: The cross sectional area (gauge), length, and the type of material the conductor is made of (usually copper).

Q11: *What factors determine the impedance of a cable?*

A11: Dielectric value of the insulation and geometry of the conductors.

Q12: *Why should cables of the same impedance be used?*

A12: Because a mismatch of impedance means a loss of energy at the mismatch.

Q13: *Why is that important to us?*

A13: Because a TDR displays the energy reflected back from an impedance mismatch.

Options and Accessories

The following options are available for the 1503C MTDR:

Option 04: YT-1 Chart Recorder

Option 04 instruments come equipped with a chart printer. Refer to the *YT-1/ YT-1S Chart Recorder Instruction Manual* that comes with this option for instructions on operation, paper replacement, and maintenance.

Option 05: Metric Default

Option 05 instruments will power up in the metric measurements mode. Standard measurements may be selected from the menu, but metric will be the default.

Option 06: Ethernet®

Option 06 instruments include circuitry that allows the 1503C to test an Ethernet bus using time-domain reflectometry with minimum disruption to the IEEE 802.3 protocol.

What is Ethernet?

Ethernet was invented by the Xerox Corporation in 1973 to allow various data devices to use a common communications bus. In an Ethernet system, signals flow in all directions and the transceivers attached to the Ethernet receive all transmissions.

Ethernet cable is typically 50 Ohms with 50-Ohm terminators at each end to prevent signal reflections. Reflections can interfere with transmissions sent out by the system.

ThinWire, Cheapernet, and Thin Ethernet are variations of Ethernet. These are usually used as a branch of the main network with a limited number of stations. They use a more flexible cable and are usually connected to each Media Access Unit (MAU) with a T-connector instead of a tap.

Segments are the smaller sub-networks in an Ethernet system. Each segment can be up to 500 meters long and have up to 100 transceiver taps. Each tap must have at least 2.5 meters of cable between itself and the next tap.

Transceivers transmit data to and from the stations on the Ethernet bus. The typical Ethernet data rate is 10 million bits per second. At each tap is a transceiver (MAU) sending and receiving this data. They also provide electrical isolation between the

coaxial cable and the station as well as housing the electronics that detect carrier signals and recognize the collision of two signals.

Taps are what the transceivers are attached to.

A **bridge** connects several network segments. Depending on the hardware used (e.g., fiber optics), a network might extend up to 22,000 meters.

Repeaters are used to increase the effective length of a cable to allow more transceivers. Due to distance limitations, two transceivers can have a maximum of two repeaters between them.

Servers let a network share resources, such as terminals, disks, printers, etc.

The 1503C with Option 06 allows testing of an Ethernet bus while the network is active. This is important because some installations might be interactive with other installations that are dependent on the Ethernet. Physically, Option 06 is a piggyback circuit board attached to the Sampler/Pulser board in the 1503C. A special EPROM replaces the standard EPROM on the main board, allowing Option 06 to be transparent to the standard instrument, but accessible through the *Ethernet Menu* and the *Setup/Acquisition Menu*.

Option 06 performs three functions:

- a 50 Ω terminator for the network
- Generates a DC signal that emulates the -1.05 VDC carrier signal
- Generates a DC signal that emulates the -1.7 VDC collision signal.

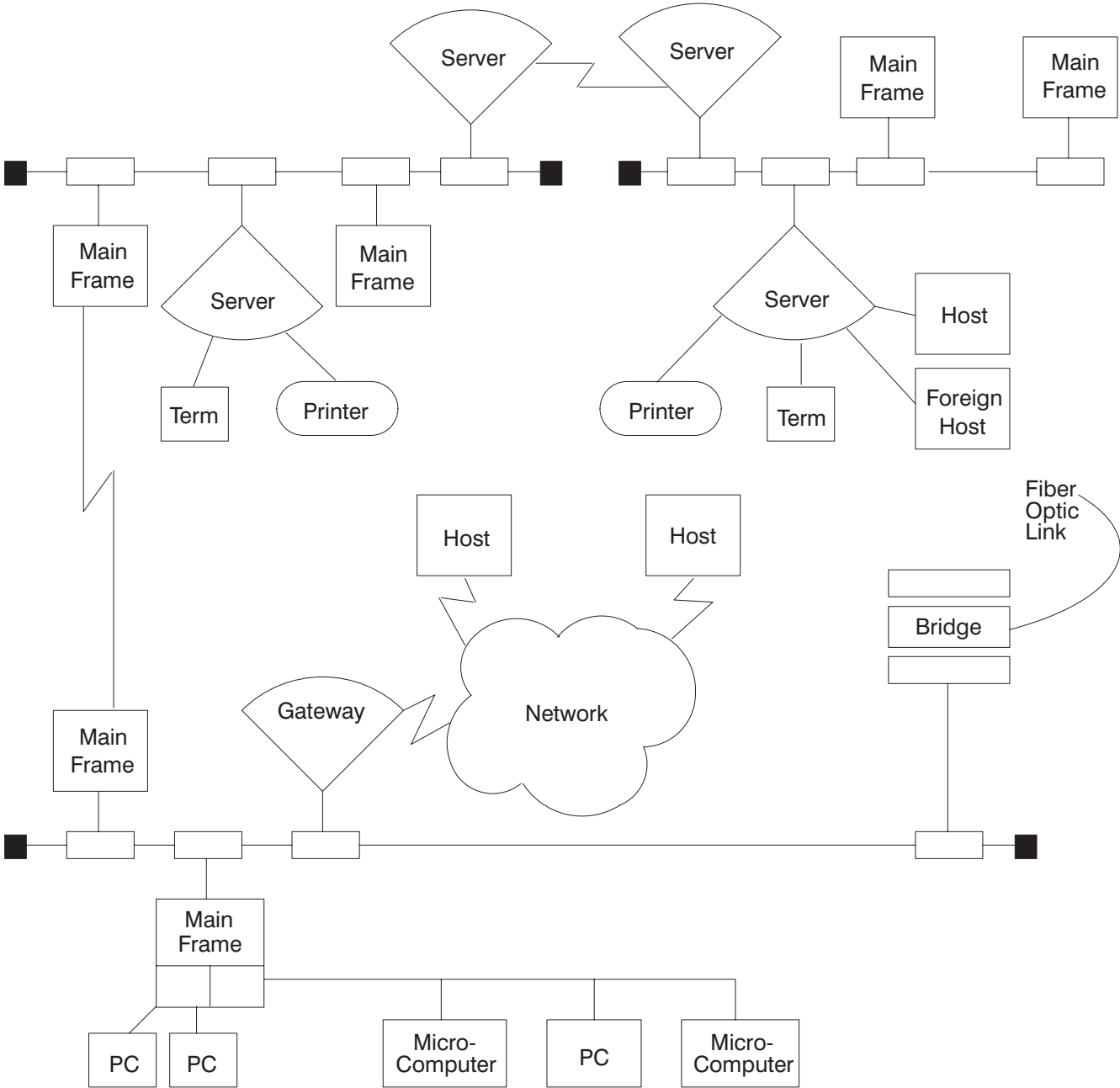

Figure 3-1: A Typical Ethernet System

Test Procedures for a Working Network

Before Starting, here are some things you should know to make Ethernet tests easier:

- You need Option 06 for testing an active network.
- Make measurements from the end of a segment.
- If possible, isolate the segment you plan to test.

- Use the shortest pulse width possible.
- Do not use Auto pulse width mode. If it selects the 100 ns or 1000 ns pulse, it might disrupt traffic on working networks.
- Use the simplest possible test first.
- Operate the 1503C on AC power when using the option chart printer.
- Changes made in the menus do not take effect until the instrument is returned to normal operation. This prevents erroneous menu selections from creating disruptions.
- Have the network documentation ready. If available, have prior TDR profiles of the network that you will be comparing.
- If possible, turn off repeaters and bridges to other networks to minimize the extent of a possible disruption the 1503C might cause.
- If you use a jumper cable, make sure that it matches the network cable impedance. The three-foot jumper furnished with the instrument is 50 Ω .

Introduction

The IEEE 802.3 standard recommends only one earth ground per segment. When connected to AC power, the 1503C provides an earth ground to the coaxial shield. There is no connection to ground when the 1503C is used with the optional battery pack and the AC power cord is disconnected.

The first test usually run on an active network is the normal sweep with the 2 ns or 10 ns pulse and the DC 50 Ω termination is: *On* from the *Ethernet Menu*. This test provides basic TDR tests with a 50 Ω termination for the net. If the network traffic is low (3 to 4%), this test is very effective. The 2 ns and 10 ns pulses are narrower than the time occupied by a single bit and usually will not cause any collisions. All other tests in the *Ethernet Menu* have potentially destructive effects on working networks.



CAUTION. *The test just described should find most problems. Before going any further, know what you are doing. Carrier and collision tests have the potential of causing problems on an active network. Read the warnings and instructions carefully. Try to limit tests to one segment during times of low traffic.*

The second test is the *Single Sweep with Carrier is: Off/On*. This test asserts the carrier signal of -1.05 V, then single-sweeps the network and drops the carrier signal. The test occupies the network for one to 20 seconds, depending on the NOISE FILTER setting.

The third test, *Carrier Test is: Off/On*, helps track down transceivers suspected of ignoring the carrier sense signal. This test holds the carrier signal of -1.05 V, turns off the pulse, and turns on MAX HOLD. The 1503C then acts as a traffic monitor.

If spikes appear on the display, it is likely a transceiver is not responding to the carrier signal and is “babbling.”

Basic Test Procedure

The following procedure describes the fundamental tests with $50\ \Omega$ DC termination is: On. When performing other Ethernet tests, use essentially the same procedure. A full description of individual tests, including custom tests, follows:

If you wish to disconnect and reconnect the 1503C to the cable segment, use a BNC T-connector between the instrument and a $50\ \Omega$ jumper cable (e.g., RG-58U). To one side of the T-connector, connect a $50\ \Omega$ terminator (the double termination is about a $25\ \Omega$ mismatch - much less likely to cause problems than an open circuit). The terminator can be removed during testing, allowing the 1503C to become the $50\ \Omega$ load. When removing the 1503C (or there is a power failure), the terminator should be reconnected, restoring the normal $50\ \Omega$ load for the network. The BNC T-connector also allows another point of access for an oscilloscope if you need to look for signal quality or noise levels.

Once the 1503C $50\ \Omega$ termination has been turned on, tests are similar to standard measurements on an coaxial $50\ \Omega$ cable. Remember to use only the 2 ns or 10 ns pulse widths. However, the waveforms might be a little different, due to traffic on the network.

Following are suggestions on how to set up test fixtures that will provide flexibility and provide network safety in case of power interruptions to the 1503C.

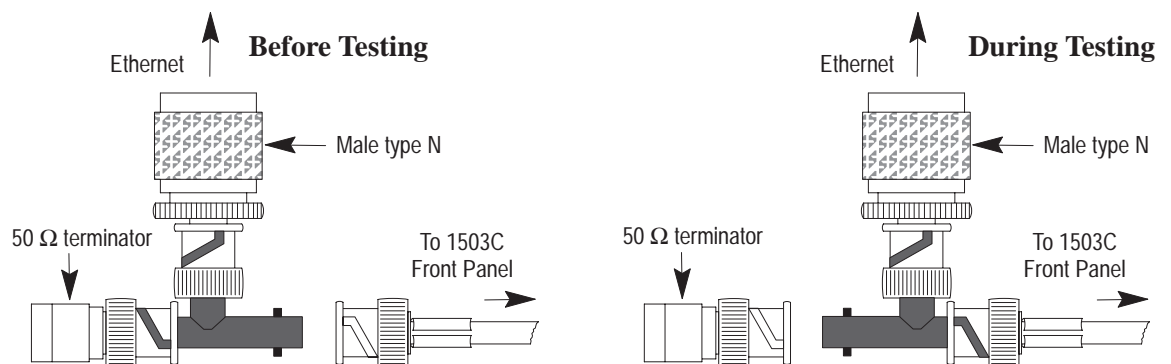

Figure 3-2: N-Type Male T-Connector

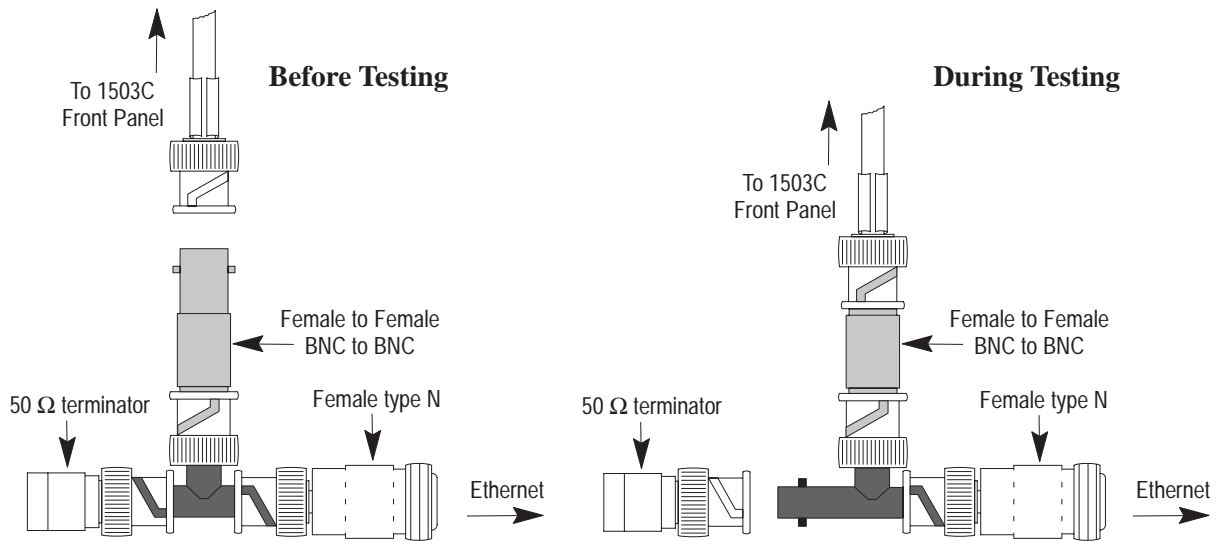

Figure 3-3: N-Type Female T-Connector

1. Before removing the Ethernet cable terminator, make sure you have the correct adapters and cables ready.
2. Set the 1503C front-panel controls:

CABLE	see below
IMPEDANCE	50 Ω
NOISE FILTER	1 avg
VERT SCALE	see below
DIST/DIV	appropriate setting for cable length
PULSE WIDTH	2 ns or 10 ns *
Vp	to cable specifications
POWER	ON (see below)



CAUTION. * DO NOT use the Auto pulse width mode. The longer pulses will cause problems on working networks.

3. Request the system administrator to notify network users of possible disruptions.
4. Using the POSITION control, access the *Ethernet Menu*.
5. Scroll to *50 Ω DC Termination is: Off* and turn it *On*.
6. Return to normal operation.
7. As previously described, connect one end of a 50 Ω jumper cable to the front-panel CABLE connector, then connect the other end to one side of the BNC T-connector (see Figures 4-2 and 4-3).

8. Connect the Ethernet cable to the BNC T-connector.
9. Remove the 50 Ω terminator.

At this point, you are testing on an active network.



CAUTION. *The 50 Ω termination of the 1503C is not maintained with the power off. In case of power failure, immediately replace the 50 Ω terminator on the BNC T-connector.*

10. With the NOISE FILTER set at 1 avg, traffic will appear as large random noise spikes. If the traffic is severe enough to make measurements difficult, increase the NOISE FILTER setting.

NOTE. *The traffic on the display has no relationship to where it came from on the cable. In fact, traffic can appear on the display beyond the end of the cable.*

11. A VERT SCALE setting of 30 dB will normally allow you to see normal taps at the near end of a network. Greater distances might require more gain, depending on the loss of the cable and the pulse width.

Descriptions of Test in the Ethernet Menu

The following tests are composed of several functions found in the *Acquisition Control Menu*. These combinations are displayed in the *Ethernet Menu* as a user convenience. Most of the tests in the *Ethernet Menu* can be recreated or modified. That is explained at the end of this section.

Changes made in the *Ethernet Menu* will affect some of the *Setup Menu* and *Acquisition Control Menu* functions. For example, if *Carrier Test is: Off/On* is turned on, the 50 Ω termination will also be turned on because it is necessary for the carrier test to work.

50 Ω DC Termination is: Off/On



CAUTION. *This must be on when testing on a working network or reflections will cause collisions on the network.*

This entry is a duplicate of the entry in the *Setup Menu/Acquisition Control Menu*. Its function is to allow direct control of the termination inside the 1503C. With the 50 Ω DC termination on, the 1503C will function normally as a cable tester. This is usually the only test needed to check a network cable.



CAUTION. *The 100 ns and 1000 ns pulses might cause collisions.*

Longer pulses are more likely to generate collisions than shorter pulses. On networks with traffic less than 3 to 4%, a 2 ns pulse causes no measurable change in network statistics. Even on heavily tapped cables, the 2 ns pulse can usually be used for distances to 700 feet. The 10 ns pulse should be suitable for those longer segments that still fall within the 802.3 specifications (under 500 meters).

Single Sweep with Carrier is: Off/On



CAUTION. *This can interrupt prior traffic and cause late collisions. It can also disrupt devices or applications that require periodic network traffic.*

When this test is selected, the 1503C will assert a -1.05 VDC signal on the net long enough to take a single waveform at the NOISE FILTER level selected. This is the equivalent to the average voltage level of a normal transmission and should cause the transceivers to assert Carrier Detect. This has the effect of causing most devices on the net to defer transmission until the 1503C is finished. This takes from about one to 20 seconds, depending on noise averaging, and reduces the traffic displayed on the waveform.

NOTE. *Movement of any control that would change or move the waveform will start a new sweep and assert the -1.05 VDC. For example, if you use the vertical position control continuously for 20 seconds, you would be asserting the false traffic for that duration and you are likely to disrupt the network.*

Carrier Test is: Off/On



CAUTION. *This carrier signal will stop traffic on the network. This might abort many application programs and might cause communications problems.*

This test asserts the -1.05 VDC signal on the network, turns off the normal 1503C pulse, and sets up the MAX HOLD mode. This is intended to help find transceivers that have a faulty Carrier Detect.

To use this test, have the network prepared for disruption and turn the test on via the *Ethernet Menu*. Any traffic observed is being transmitted in spite of a signal simulating a carrier. This might be due to a transceiver not asserting its carrier detect line, a host not reading its carrier detect line, or some other reason. This is not unusual with some equipment. One way to isolate which units are doing this is to disconnect them one at a time until it stops.

Collision Test is: Off/On

CAUTION. *The collision signal will stop traffic on the network. This might abort many application programs and might cause communications problems.*

This test is similar to the carrier test except that it asserts a -1.7 VDC signal to simulate a collision on the network.

**Descriptions of Tests in
the Setup Menu/
Acquisition Control Menu**

The entries in this menu allow you to set up custom tests on networks in addition to the preset ones in the *Ethernet Menu*. This is intended for users who are familiar enough with Ethernet to anticipate the results. Changes in this menu can affect the state of other entries that are mutually exclusive or necessary for the chosen entry. For example, turning on the *Collision Output Signal is: Off/On* will also turn off the carrier output signal because only one voltage can be sent out.

Only the function of the entries unique to Option 06 will be explained. For the others, refer to the *Operating Instructions* chapter of this manual.

50 Ω DC Termination is: Off/On

CAUTION. *This must be on for use on a working network or reflections will cause collisions on the network.*

This entry is a duplicate of the entry in the Ethernet Menu. Its function is to allow direct control of the low frequency termination inside the 1503C. With the *50 Ω DC termination is: On*, the 1503C will function normally to test the cable. This is usually the only test needed to check a network cable.

Carrier (-1.05 V) Output Signal is: Off/On

CAUTION. *The carrier signal will stop most traffic on the network. This might abort many application programs and might cause communications problems.*

When this test is on, the 1503C will assert a -1.05 VDC level on a 50 Ω load (-2.1 VDC open circuit). This signal is intended to be equivalent to the average of a standard Ethernet transmission and should trigger the carrier detect circuit on all the transceivers. Because most applications will defer transmission when this signal is present, it can be used to test transceivers and systems, or to reduce traffic for 1503C testing.

Collision (-1.7 V) Output Signal is: Off/On



CAUTION. *The collision signal will stop most traffic on the network. This might abort many application programs and might cause communications problems.*

When this test is on, the 1503C will assert a -1.7 VDC level on a 50 Ω load (-3.4 VDC open circuit). This signal is intended to be equivalent to the average of two colliding Ethernet transmissions and should trigger the collision detect circuit on all the transceivers. This should cause applications to back off and retry, then eventually abort, as defined in the 802.3 standard. Therefore, it can be used to test units that do not respond to this signal or to stop traffic for TDR testing.

Customizing Your Own Tests

Access the *Acquisition Control Menu* located under the *Setup Menu*. The various tests listed can be used in any combination. Remember that the tests will not be activated until you return the 1503C to normal operation, so any combination can be chosen, then activated.

Waveform Signatures

By now you probably have a good idea what traffic looks like on the display and how you can use the NOISE FILTER to reduce it. Other signatures might also appear on the display.

Terminators are small reflections seen as stationary bumps and dips. A perfect terminator would not reflect any energy, and theoretically would be invisible on the 1503C display. Because of small impedance differences between the cable and the terminator, a small amount of energy will be reflected. The signature of a terminator tends to go either up or down. Because a terminator absorbs nearly all the energy of a pulse, the normal ripples in the waveform (minor changes in impedance) will not be present after a terminator. The point where the waveform becomes flat is a clue to the location of a terminator.

Taps commonly have a characteristic down-then-up reflection. The TDR pulse will continue to travel past a tap because only part of the pulse's energy is reflected. This allows the 1503C to read signatures well beyond taps.

Following are examples of tests made on two Ethernet systems:

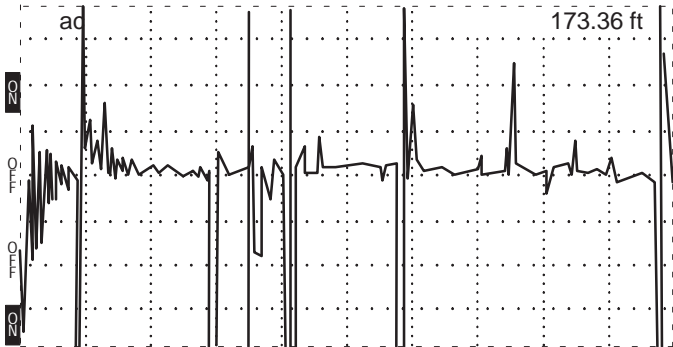

Figure 3-4: System 1 - Tap Hidden by Traffic (1 avg, 50 ft/div, 35 dB)

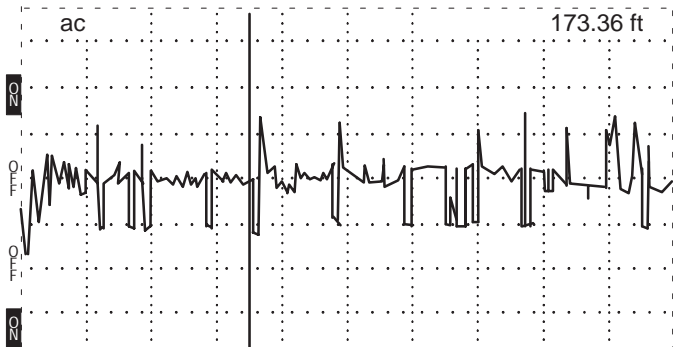

Figure 3-5: System 1 - Traffic and Tap Nearly Identical (4 avg, 50 ft/div, 35 dB)

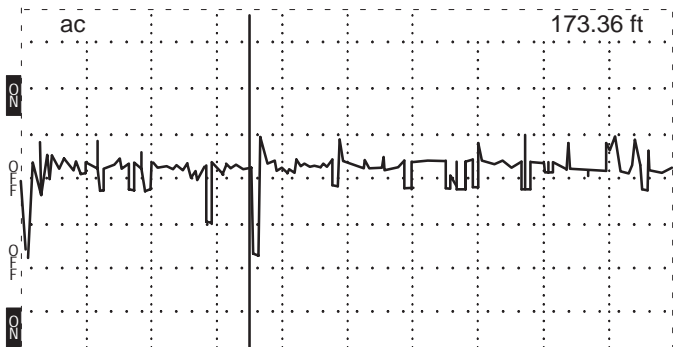

Figure 3-6: System 1 - Tap Becoming Visible (16 avg, 50 ft/div, 35 dB)



Figure 3-7: System 1 - Tap Quite Visible
(128 avg, 50 ft/div, 35 dB)

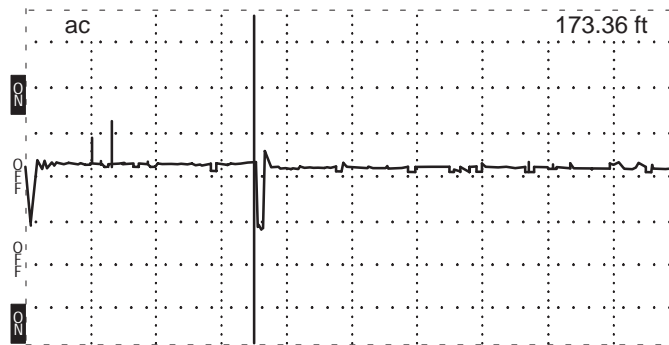

Figure 3-8: System 1 - No Traffic
(1 avg, 50 ft/div, 35 dB)

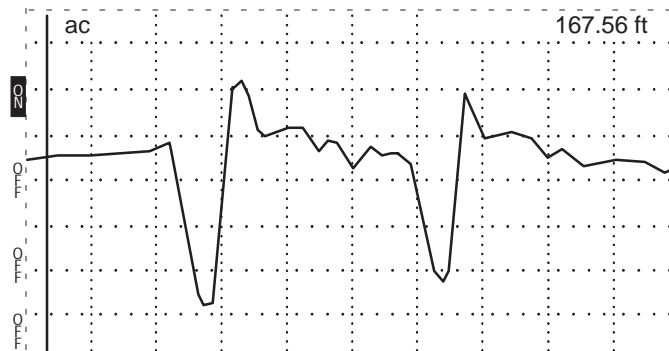

Figure 3-9: System 1 - Tap Expanded, No Traffic
(1 avg, 2 ft/div, 35 dB)

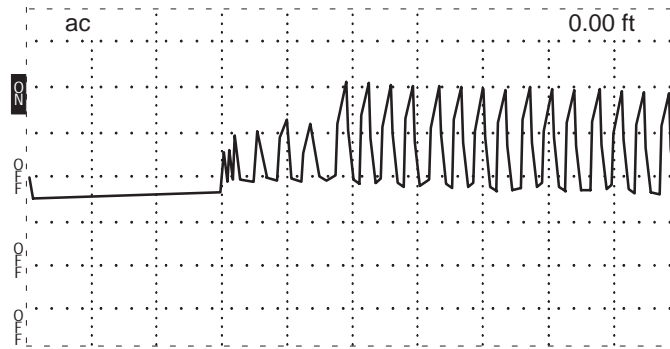

Figure 3-10: System 2 - Cable w/ Revision One Repeater *
(1 avg, 200ft/div, 2.25dB)

* Revision One repeaters must sense collisions and place a jam signal on both segments. When using the carrier sense voltage level while sending out pulses (e.g., Single Sweep with Carrier is: On) the pulses might exceed the collision or traffic thresholds of the repeater, causing it to send back jamming packets that are synchronized with the 1503C. This creates an unusual waveform that looks similar to data. As a rule, repeaters should be shut down prior to testing a segment to prevent such occurrences.

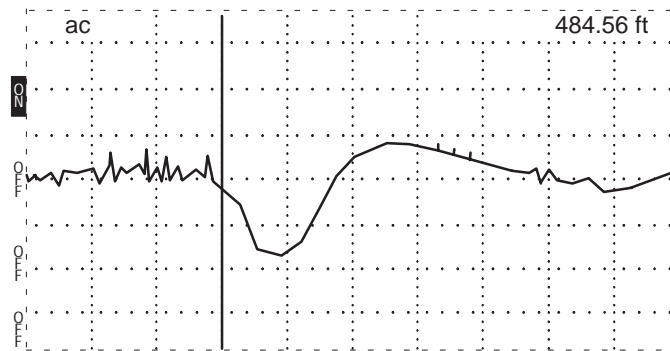

Figure 3-11: System 2 - First Tap, No Traffic
(1 avg, 1 ft/div, 44.5 dB)

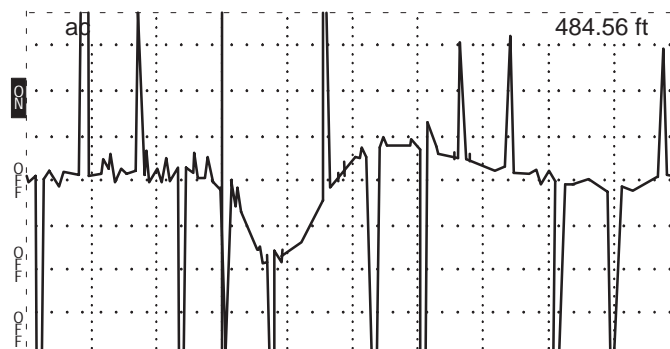
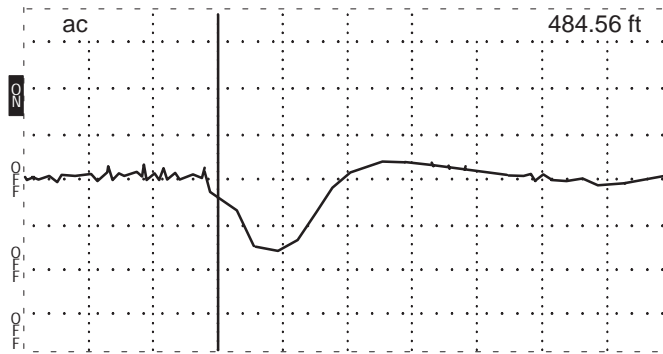
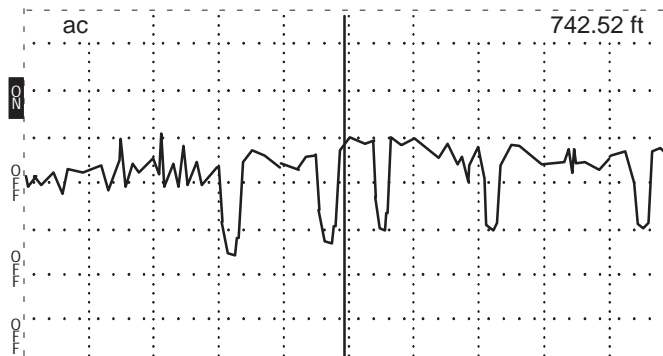

Figure 3-12: System 2 - Same Tap with 5% Traffic
(1 avg, 1 ft/div, 44.5 dB)



**Figure 3-13: System 2 - Same Tap, Increased Averaging
(16 avg, 1 ft/div, 44.5 dB)**



**Figure 3-14: System 2 - Farther Out, More Gain
(128 avg, 10 ft/div, 53.5 dB)**

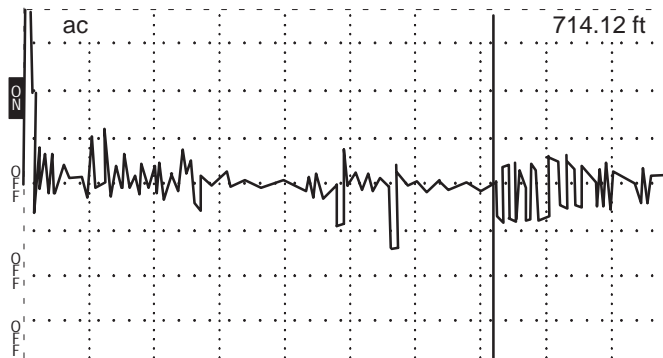

**Figure 3-15: System 2 - 1000-ft Cable at 10 ns
(128 avg, 100 ft/div, 43.75 dB)**

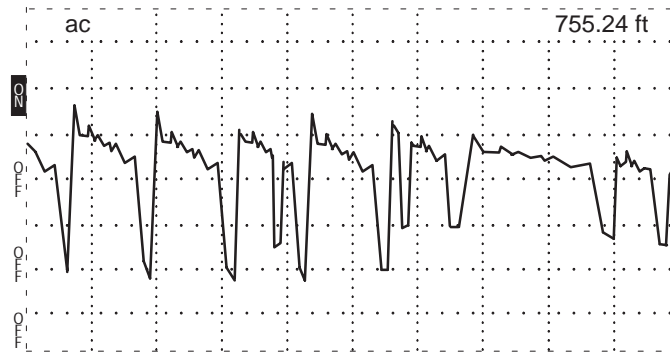

Figure 3-16: System 2 - Previous Waveform Expanded
(128 avg, 20 ft/div, 54.75 dB)

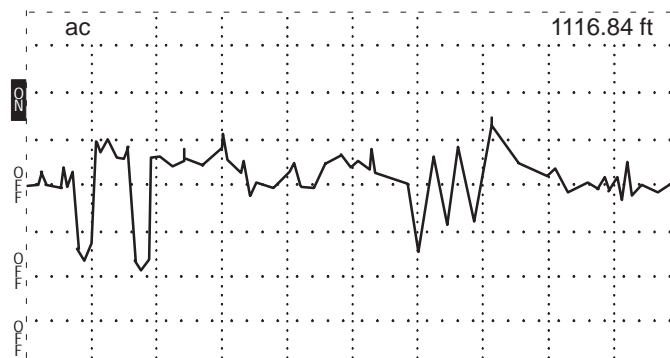

Figure 3-17: System 2 - Next Group of Taps
(128 avg, 20 ft/div, 54.75 dB)

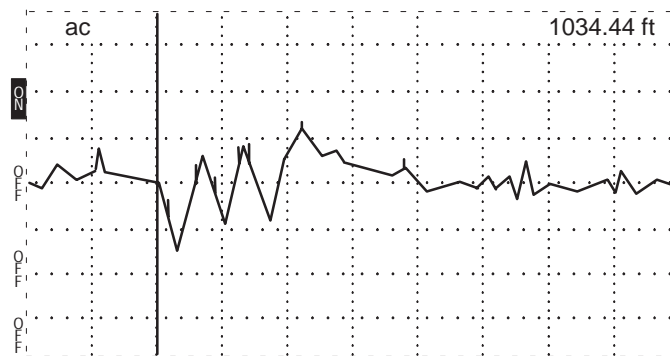

Figure 3-18: System 2 - Group of Taps Expanded
(128 avg, 10 ft/div, 54.75 dB)

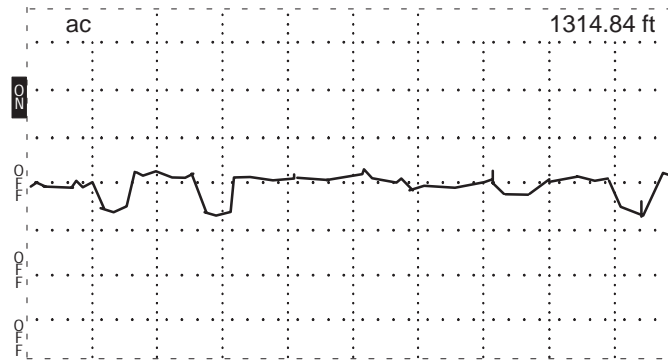

Figure 3-19: System 2 - Another Group of Taps
(128 avg, 10 ft/div, 54.75 dB)

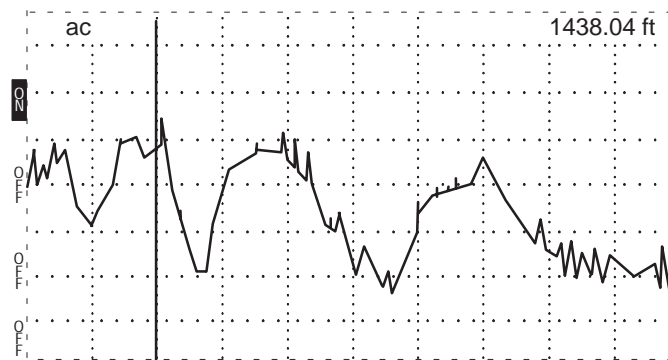

Figure 3-20: System 2 - End of Cable
(128 avg, 20 ft/div, 61.25 dB)

Electrical Characteristics

Following are the specifications for the Ethernet board.

Characteristic	Performance Requirement	Supplemental Information
DC Termination	50 Ω , $\pm 1 \Omega$	See typical frequency response curve below this table to estimate at other frequencies. Once the termination is turned on, it will remain on until specifically turned off by the operator, at which time a warning to remove the 1503C from the network will be shown on the display. Leaving the TDR on the network with the termination turned off will cause traffic disruption and errors.
DC Voltage Offsets	0.0 V ± 0.02 V -1.05 VDC and -1.7 VDC ± 0.15 V into 50 Ω	AC pulse voltage is present on top of DC offsets while measuring. Voltages only asserted when 50 Ω termination is on.

Characteristic	Performance Requirement	Supplemental Information
Overvoltage Protection		Circuit cuts out leaving standard 1503C protection for voltages greater than ± 11 V.
Floating Ground		Only when used with battery pack. IEEE 802.3 specifies a single ground on the bus.

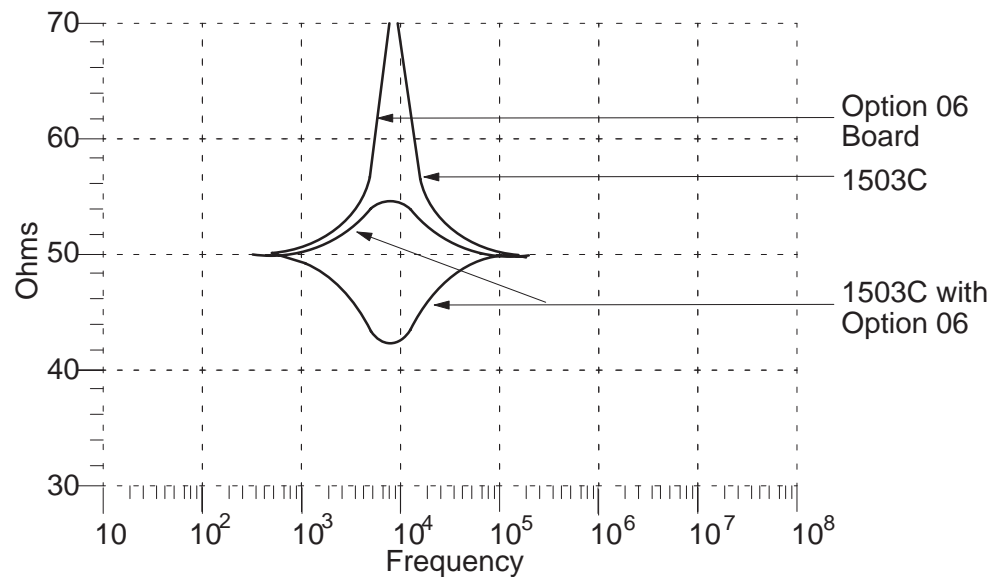

Figure 3-21: Typical Frequency Response Curve with Ethernet Option 06

Option 07: YT-1S Chart Recorder

Option 07 instruments come equipped with a splashproof chart printer. Refer to the *Y-1/ YT-1S Chart Recorder Instruction Manual* that comes with this option for instructions on operation, paper replacement, and maintenance.

Option 08: Token Ring Adapter

Option 08 instruments come with an adapter that allows you to connect the 1503C to networks containing ECL connectors. The adapter isolates the receive pair from the transmit pair at the ECL connector and allows you to select one or the other to be routed to the input BNC connector on the 1503C.

Option 09: Universal Service Ordering Code

Option 09 instruments come with an adapter that allows you to connect the 1503C to LANs using type RJ-45 connectors using the Universal Service Ordering Code. The adapter allows selection of each of the four twisted pairs.



CAUTION. *The RJ-45 USOC adapter (Option 09) is the same connector used for many telephone installations. Active telephone wires will have 40 to 60 VDC on one pair and this will destroy the 1502-series instrument. Do not use Option 09 with 1502, 1502B or 1502C instruments.*

Option 10: Token Ring Interface

Option 10 instruments come with an adapter that allows you to connect the 1503C to Token Ring networks via the MAU.

Power Cord Options

The following power cord options are available for the 1503C TDR. Note that these options require inserting a 0.15 A fuse in the rear panel fuse holder.

NOTE. *The only power cord rated for outdoor use is the standard cord included with the instrument (unless otherwise specified). All other optional power cords are rated for indoor use only.*

Option A1:	220 VAC, 16 A, Universal Europe	161-0066-09
Option A2:	240 VAC, 13 A, United Kingdom	161-0066-10
Option A3:	240 VAC, 10 A, Australia	161-0066-11
Option A4:	240 VAC, 15A, North America	161-0066-12
Option A5:	240 VAC, 6 A, Switzerland	161-0154-00

Accessories

Standard Accessories

■ Internal Lead-gel Battery Assembly	016-0915-00
■ Replacement Fuse (AC line fuse, 115 VAC)	159-0029-01
■ Replacement Fuse (AC line fuse, 230 VAC)	159-0054-00
■ Power Cord (outdoor rated)	161-0228-00
■ Option Port Cover Assembly	200-3737-00
■ 50 Ω BNC Terminator	011-0123-00
■ BNC Connector, female-to-female	103-0028-00
■ 93 Ω 10-foot Test Cable (S/N \geq B010625)	012-1351-00
■ Connector, BNC female to Alligator Clips (S/N \geq B010625) . .	013-0261-00
■ BNC Connector male to N female (w/ Option 06 only)	103-0058-00
■ 50 Ω 3-foot Test Cable (w/ Option 06 only)	012-1350-00
■ Operator Manual	070-7323-xx
■ Slide Rule Calculator	003-1419-00
■ Accessory Pouch	016-0814-00

Optional Accessories

■ Service Manual	070-7170-xx
■ Battery	040-1276-00
■ Chart Recorder, YT-1S	119-3616-00
■ Chart Paper, single roll	006-7647-00
■ Chart Paper, 25-roll pack	006-7677-00
■ Chart Paper, 100-roll pack	006-7681-00
■ Cable, Interconnect, 360 inches	012-0671-03
■ Connector, BNC male to BNC male	103-0029-00
■ Connector, BNC female to Alligator Clip (S/N \geq B010625) . .	013-0261-00
■ Connector, BNC female to Hook-tip Leads	013-0076-01
■ Connector, BNC female to Dual Banana Plug	103-0090-00
■ Connector, BNC male to Dual Binding Post	103-0035-00
■ Connector, BNC male to N female	103-0058-00

- Connector, BNC female to N male 103-0045-00
- Connector, BNC female to UHF male 103-0015-00
- Connector, BNC female to UHF female 103-0032-00
- Connector, BNC female to Type F male 103-0158-00
- Connector, BNC male to Type F female 013-0126-00
- Connector, BNC female to GR 017-0063-00
- Connector, BNC male to GR 017-0064-00
- Precision 50 Ω Cable (S/N \geq B010625) 012-1350-00
- Terminator, 75 Ω BNC 011-0102-00
- Adapter, Direct Current 015-0327-00
- Isolation Network 013-0169-00
- Pulse Inverter 015-0495-00
- Token Ring Network Adapter 015-0500-00
- Twisted Pair Adapter - USOC Adapter 015-0579-00
- Token Ring Interface 015-0600-00

Appendix A: Specifications

The tables in this chapter list the characteristics and features that apply to this instrument after it has had a warm-up period of at least five minutes.

The Performance Requirement column describes the limits of the Characteristic. Supplemental Information describes features and typical values or other helpful information.

Electrical Characteristics

Characteristic	Performance Requirement	Supplemental Information
Test Pulse Width Accuracy	Selected: 2 ns, 10 ns, 100 ns, 1000 ns 2 ns \pm 1 ns; 10 ns, 100 ns, 1000 ns \pm 10%	Measured at half sine amplitude point with matching termination.
Pulse Amplitude Terminated Unterminated	-2.5 VDC \pm 10% for 10 ns, 100 ns, 1000 ns; 2 ns \pm 20% -5.0 VDC \pm 10% for 10 ns, 100 ns, 1000 ns	Internal cable length prevents 2 ns pulse from reaching full unterminated voltage
Pulse Shape	1/2 sine	
Pulse Output Impedance Accuracy	Selected: 50 Ω , 75 Ω , 93 Ω , 125 Ω 1%	
Pulse Repetition Time	350 μ s nominal	
Vertical Scale Accuracy Set Adjustment Vertical Position	0 dB to 63.75 dB gain \pm 3% Set incident pulse within \pm 3% Any waveform point moveable to center screen.	256 values at 0.25 dB increments Combined with vertical scale control.
Displayed Noise Random Aberrations	$\leq \pm$ 1.0 division peak with 57 dB gain, filter set to 1 $\leq \pm$ 1.0 division peak with 63 dB gain, filter set to 8 \leq -30 dB p-p for 10 ns, 100 ns, 1000 ns test pulse \leq -25 dB p-p for 2 ns test pulse	With matching terminator at panel. Beyond three test pulse widths after test pulse. Within three test pulse widths after test pulse. dB is relative to test pulse.

(continued next page)

Appendix A: Specifications

Characteristic	Performance Requirement	Supplemental Information
Cable Connection Coupling	Capacitively coupled	
Max Input Susceptibility	± 400 V (DC + peak, AC at maximum frequency of 440 Hz). No damage with application for up to 30 seconds (might affect measurement capability).	
Distance Cursor Resolution	1/25 of 1 major division	
Cursor Readout Range	-2 ft to $\geq 50,000$ ft (-0.61 m to 15,230 m)	5 digit readout
Resolution	0.04 ft	
Accuracy	Within 2% ± 0.02 ft at 1 ft/div	Vp must be set within $\pm 0.5\%$ of cable
Horizontal Scale	1 ft/div to 5000 ft/div (0.25 m/div to 1000 m/div) 12 values: 1, 2, 5 sequence	
Range	0 to 50,000 ft (0 to 10,000 m)	
Horizontal Position	Any distance to full scale can be moved on screen	
Vp Range	0.30 to 0.99	Propagation velocity relative to air
Resolution	0.01	
Accuracy	within $\pm 1\%$	
Custom Option Port		Tek chart recorder is designed to operate with the 1503C. Produces a high resolution thermal dot matrix recording and waveform and control values.
Line Voltage	115 VAC (90 to 132 VAC) 45 to 440 Hz 230 VAC (180 to 250 VAC) 45 to 440 Hz	Fused at 0.3 A Fused at 0.15 A
Battery Pack Operation	8 hours minimum, 30 chart recordings maximum	+15° C to +25° C charge and discharge temperature, LCD backlight off. Operation of instrument with backlight on or at temperatures below +10° C will degrade battery operation specification
Full Charge Time	20 hours maximum	
Overcharge Protection	Charging discontinues once full charge is attained	
Discharge Protection	Operation terminates prior to battery damage	
Charge Capacity	3.4 Amp-hours typical	
Charge Indicator	Bat/low will be indicated on LCD when capacity reaches approximately 10%	

Environmental Characteristics

Characteristic	Performance Requirement	Supplemental Information
Temperature Operating	-10° C to +55° C	Battery capacity reduced at other than +15°C to +25°C
Non-operating	-62° C to +85° C	With battery removed. Storage temp with battery in is -20° C to +55° C. Contents on non-volatile memory (stored waveform) might be lost at temps below -40° C.
Humidity	to 100%	
Altitude Operating	to 10,000 ft	MIL-T-28800C, Class 3
Non-operating	to 40,000 ft	
Vibration	5 to 15 Hz, 0.06 inch p-p 15 to 25 Hz, 0.04 inch p-p 25 to 55 Hz, 0.013 inch p-p	MIL-T-28800C, Class 3
Shock, Mechanical Pulse	30 g, 11 ms 1/2 sine wave, total of 18 shocks	MIL-T-28800C, Class 3
Bench Handling		MIL-STD-810, Method 516, Procedure V
Operating	4 drops each face at 4 inches or 45 degrees with opposite edge as pivot	Cabinet on, front cover off
Non-operating	4 drops each face at 4 inches or 45 degrees with opposite edge as pivot. Satisfactory operation after drops.	Cabinet off, front cover off
Loose Cargo Bounce	1 inch double-amplitude orbital path at 5 Hz, 6 faces	MIL-STD-810, Method 514, Procedure XI, Part 2
Water Resistance Operating	Splash-proof and drip-proof	MIL-T-28800C, Style A Front cover off
Non-operating	Watertight with 3 feet of water above top of case	Front cover on
Salt Atmosphere	Withstand 48 hours, 20% solution without corrosion	
Sand and Dust	Operates after test with cover on, non-operating	MIL-STD-810, Method 510, Procedure I
Washability	Capable of being washed	
Fungus Inert	Materials are fungus inert	

(continued next page)

Certifications and Compliances

Category	Standard or description
EC Declaration of Conformity – EMC	Meets intent of Directive 89/336/EEC for Electromagnetic Compatibility. Compliance was demonstrated to the following specifications as listed in the Official Journal of the European Union: EN 50081-1 Emissions: EN 55022 Class B Radiated and Conducted Emissions EN 60555-2 AC Power Line Harmonic Emissions EN 50082-1 Immunity: IEC 801-2 Electrostatic Discharge Immunity IEC 801-3 RF Electromagnetic Field Immunity IEC 801-4 Electrical Fast Transient/Burst Immunity IEC 801-5 Power Line Surge Immunity
Australia/New Zealand Declaration of Conformity – EMC	Complies with EMC provision of Radiocommunications Act per the following standard(s): AS/NZS 2064.1/2 Industrial, Scientific, and Medical Equipment: 1992
EMC Compliance	Meets the intent of Directive 89/336/EEC for Electromagnetic Compatibility when it is used with the product(s) stated in the specifications table. Refer to the EMC specification published for the stated products. May not meet the intent of the directive if used with other products.
FCC Compliance	Emissions comply with FCC Code of Federal Regulations 47, Part 15, Subpart B, Class A Limits.
Safety Standards	
U.S. Nationally Recognized Testing Laboratory Listing	UL1244 Standard for electrical and electronic measuring and test equipment.
Canadian Certification	CAN/CSA C22.2 No. 231 test equipment. CSA safety requirements for electrical and electronic measuring and
European Union Compliance	Low Voltage Directive 73/23/EEC, amended by 93/68/EEC EN 61010-1/A2 Safety requirements for electrical equipment for measurement, control, and laboratory use.
Additional Compliance	IEC61010-1/A2 Safety requirements for electrical equipment for measurement, control, and laboratory use.
Safety Certification Compliance	
Equipment Type	Test and measuring
Safety Class	Class 1 (as defined in IEC 61010-1, Annex H) – grounded product
Overvoltage Category	Overvoltage Category II (as defined in IEC 61010-1, Annex J)
Pollution Degree	Pollution Degree 3 (as defined in IEC 61010-1).
Installation (Overvoltage) Category	Terminals on this product may have different installation (overvoltage) category designations. The installation categories are: CAT III Distribution-level mains (usually permanently connected). Equipment at this level is typically in a fixed industrial location. CAT II Local-level mains (wall sockets). Equipment at this level includes appliances, portable tools, and similar products. Equipment is usually cord-connected. CAT I Secondary (signal level) or battery operated circuits of electronic equipment.

(continued next page)

Category	Standard or description
Pollution Degree	<p>A measure of the contaminates that could occur in the environment around and within a product. Typically the internal environment inside a product is considered to be the same as the external. Products should be used only in the environment for which they are rated.</p> <p>Pollution Degree 1 No pollution or only dry, nonconductive pollution occurs. Products in this category are generally encapsulated, hermetically sealed, or located in clean rooms.</p> <p>Pollution Degree 2 Normally only dry, nonconductive pollution occurs. Occasionally a temporary conductivity that is caused by condensation must be expected. This location is a typical office/home environment. Temporary condensation occurs only when the product is out of service.</p> <p>Pollution Degree 3 Conductive pollution, or dry, nonconductive pollution that becomes conductive due to condensation. These are sheltered locations where neither temperature nor humidity is controlled. The area is protected from direct sunshine, rain, or direct wind.</p> <p>Pollution Degree 4 Pollution that generates persistent conductivity through conductive dust, rain, or snow. Typical outdoor locations.</p>

Physical Characteristics

Characteristic	Description	
Weight	without cover	14.5 lbs (6.57 kg)
	with cover	16 lbs (7.25 kg)
	with cover, chart recorder, and battery pack	20 lbs (9.07 kg)
Shipping Weight	domestic	25.5 lbs (11.57 kg)
	export	25.5 lbs (11.57 kg)
Height		5.0 inches (127 mm)
Width	with handle	12.4 inches (315 mm)
	without handle	11.8 inches (300 mm)
Depth	with cover on	16.5 inches (436 mm)
	with handle extended to front	18.7 inches (490 mm)

Appendix B: Operator Performance Checks

This appendix contains performance checks for many of the functions of the 1503C. They are recommended for incoming inspections to verify that the instrument is functioning properly. Procedures to verify the actual performance requirements are provided in the *1503C Service Manual*.

Performing these checks will assure you that your instrument is in good working condition. These checks should be performed upon receipt of a new instrument or one that has been serviced or repaired. It does not test all portions of the instrument to Calibration specifications.

The purpose of these checks is not to familiarize a new operator with the instrument. If you are not experienced with the instrument, you should read the *Operating Instructions* chapter of this manual before going on with these checks.

If the instrument fails any of these checks, it should be serviced. Many failure modes affect only some of the instrument functions.

Equipment Required

Item	Tektronix Part Number
50 Ω precision terminator	011-0123-00
93 Ω 10-foot coaxial cable	012-1351-00

Getting Ready

Disconnect any cables from the front-panel CABLE connector. Connect the instrument to a suitable power source (a fully charged battery pack or AC line source). If you are using AC power, make sure the fuse and power switch are correct for the voltage you are using (115 VAC requires a different fuse than 230 VAC).

Power On

Pull the POWER switch on the front panel. If a message does not appear on the display within a second or two, turn the instrument off. There are some failure modes that could permanently damage or ruin the LCD if the power is left on for more than a minute or so. Refer to *Appendix C: Operator Troubleshooting* in this manual.

Metric Instruments

Option 05 instruments default to metric; however, you can change the metric scale to ft/div in the *Setup Menu* or use the metric numbers provided. To change the readings, press the MENU button. Using the Δ POSITION control, scroll down to *Setup Menu* and press MENU again. Scroll down to *Distance/Div is: m/div* and press MENU again. This will change to ft/div. Press the MENU button repeatedly to return to normal operation mode. If the instrument power is turned off, these checks must be repeated again when the instrument is powered on again.

Set Up Set the 1503C front-panel controls:

IMPEDANCE	93 Ω
NOISE FILTER	1 avg
VERT SCALE	10.00 dB
DIST/DIV	2 ft/div (0.25 m)
V _p	.84
PULSE WIDTH	2 ns

1. Horizontal Scale (Timebase) Check

If the instrument fails this check, it must be repaired before any distance measurements can be made with it.

1. Turn the 1503C power on. The display should look very similar to Figure B-1.

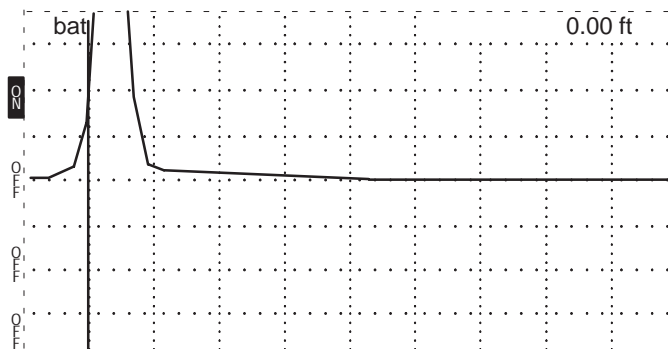

Figure B-1: Start-up Measurement Display

2. Connect the 10-foot cable to the front-panel CABLE connector. The display should now look like Figure B-2.

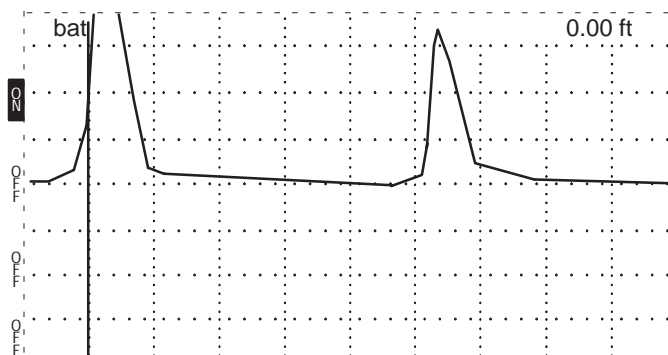

Figure B-2: Measurement Display with 10-foot Cable

3. Using the $\langle \triangleright \rangle$ POSITION control, measure the distance to the rising edge of the waveform at the open end of the cable. The distance shown on the display distance window (upper right corner of the LCD) should be from 9.7 to 10.3 feet (2.95 to 3.14 m).

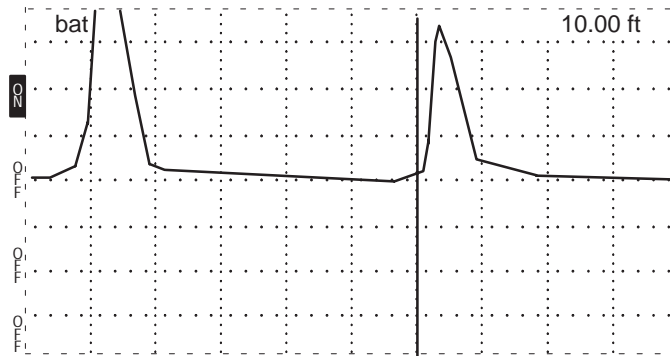

Figure B-3: Cursor at End of 10-foot Cable

4. Change the V_p to .30. Using the $\langle \triangleright \rangle$ POSITION control, measure the distance to the rising edge of the waveform at the open end of the cable. The distance shown on the display distance window (upper right corner of the LCD) should be from 3.50 to 3.70 feet (1.05 to 1.11 m).

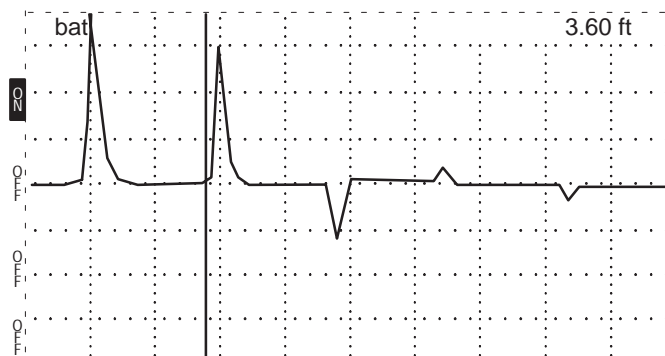

Figure B-4: Cursor at End of 10-foot Cable, V_p Set to .30

5. Remove the 10-foot cable and connect the 50Ω terminator. Change the 1503C front-panel controls to:

VERT SCALE	0.00 dB
DIST/DIV	5000 ft/div (1000 m/div)
PULSE WIDTH	1000 ns

6. Turn the $\langle \triangleright \rangle$ POSITION control clockwise until the display distance window reads a distance greater than 50,000 feet (15,259 m). The waveform should remain a flat line from zero to this distance.



Figure B-5: Flatline Display Out to 50,000+ Feet

2. Vertical Position (Offset) Check

If the instrument fails this test, it can be used, but should be serviced when possible. Not all of the waveforms will be viewable at all gain settings.

1. Using the ∇ POSITION control, verify that the entire waveform can be moved to the very top of the display (off the graticule area).

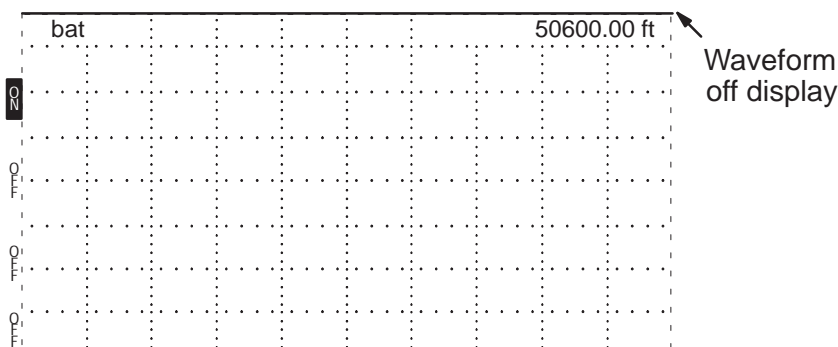

Figure B-6: Waveform Off the Top of the Display

2. Using the ∇ POSITION control, verify that the entire waveform can be moved to the very bottom of the display (to the bottom graticule line).

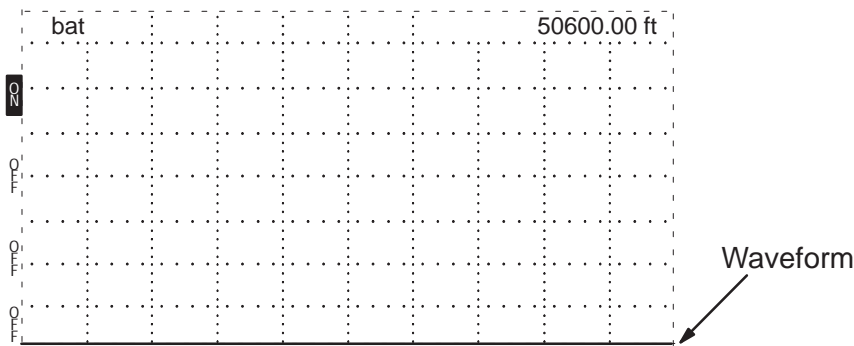

Figure B-7: Waveform at the Bottom of the Display

3. Noise Check

If the instrument fails this check, it may still be usable for measurements of large faults that do not require a lot of gain. A great deal of noise reduction can be made using the NOISE FILTER control. Send your instrument to be serviced when possible.

1. Set the PULSE WIDTH to 2 ns. Using the Δ POSITION control and VERT SCALE control, set the gain to 57 dB with the waveform centered vertically in the display.

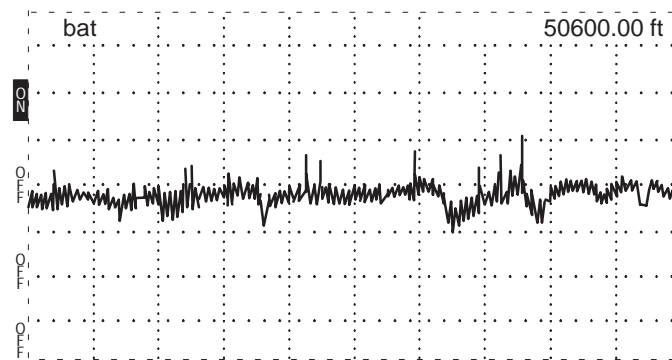

Figure B-8: Waveform with Gain at 57 dB

2. Press MENU.
3. Using the Δ POSITION control, select *Diagnostics Menu*.
4. Press MENU again.
5. Using the Δ POSITION control, select *Service Diagnostic Menu*.
6. Press MENU again.
7. Using the Δ POSITION control, select *Noise Diagnostics*.
8. Press MENU again and follow the instructions on the display.
9. Exit from *Noise Diagnostics*, but do not exit from the *Service Diagnostic Menu* yet.

4. Offset/Gain Check

If the instrument fails this check, it should not be used for loss or impedance measurements. Send it to be serviced when possible.

1. In the *Service Diagnostic Menu*, select the *Offset/Gain Diagnostic* and follow the directions on the display.

There are three screens of data presented in this diagnostic. The Pass/Fail level is 3% for any single gain setting tested.

2. Exit from *Offset/Gain Diagnostic*, but do not leave the *Service Diagnostic Menu* yet.

5. Impedance Check

If the instrument fails this check, it should not be used for loss or impedance measurements.

1. In the *Service Diagnostic Menu*, select the *Impedance Diagnostic* and follow the directions on the screen. Passable tolerances are:

50 Ω	47.0 to 50.0 Ω
75 Ω	71.0 to 75.0 Ω
93 Ω	88 to 93 Ω
125 Ω	118 to 125 Ω

2. Exit from the *Impedance Diagnostic*, but do not leave the *Service Diagnostic Menu* yet.

6. Sampling Efficiency Check

If the instrument fails this check, the waveforms might not look normal. If the efficiency is more than 100%, the waveforms will appear noisy. If the efficiency is below the lower limit, the waveform will take longer (more pixels) to move from the bottom to the top of the reflected pulse. This smoothing effect might completely hide some faults that would normally only be one or two pixels wide on the display.

1. In the *Service Diagnostic Menu*, select *Sampling Efficiency* and follow the directions on the screen.
2. When done with the test, press the MENU button repeatedly until the instrument returns to normal operation.

7. Aberrations Check

If the aberrations are too large, they can be confused with minor faults in the cable near the instrument.

1. Turn the $\langle \triangleright \rangle$ POSITION control counterclockwise until the display distance window reads less than 20.00 ft (6.10 m).
2. Set the DIST/DIV control to 1 ft/div (0.25 m/div).

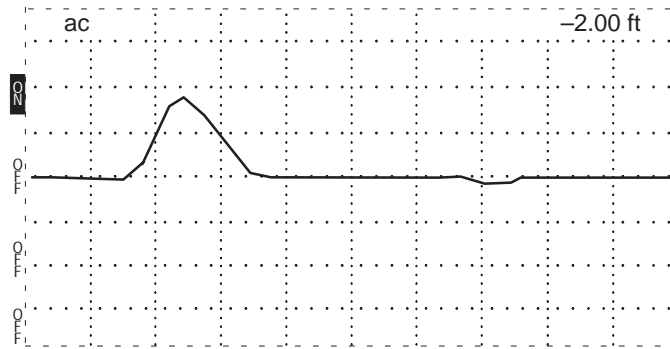

Figure B-9: Distance at -2.00 ft

3. Turn the $\langle \triangleright \rangle$ POSITION control counterclockwise until the display distance window reads -2.00 ft (-0.62 m).

4. Set the 1503C front-panel controls:

IMPEDANCE	50 Ω
NOISE FILTER	1 avg
VERT SCALE	0.00 dB
PULSE WIDTH	2 ns
V _p	.99

5. Connect the 50 Ω precision terminator to the front panel.

6. Turn the NOISE FILTER control completely counterclockwise to the VERT SET REF position.

7. Use VERT SCALE to increase the height of the pulse to four major divisions.

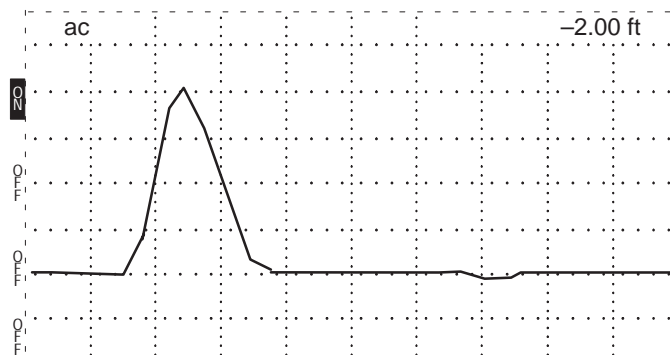

Figure B-10: Pulse Adjusted to Four Major Divisions in Height

8. Press STORE.

9. Turn the NOISE FILTER control back to 1 avg.

10. Place the baseline of the waveform on the center graticule using the Δ POSITION control.
11. Increase VERT SCALE to 25.00 dB
12. Using the \triangleleft \triangleright POSITION control, verify that the aberrations are less than four divisions high out to 10 feet (3.05 m).

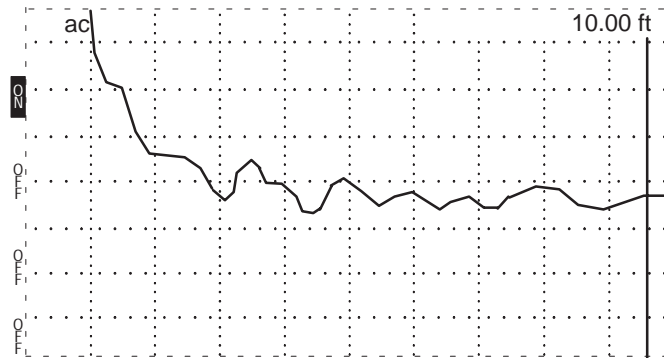

Figure B-11: Waveform Centered, Cursor at 10.00 ft

13. Return the cursor to -2.00 ft (-0.61 m).
14. Turn NOISE FILTER back to VERT SET REF.
15. Set the DIST/DIV to 2 ft/div (0.5 m/div).
16. Turn PULSE WIDTH to 10 ns.
17. Adjust the pulse height to four major divisions.

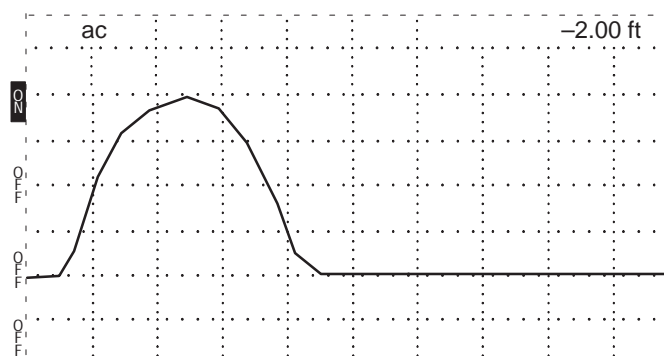

Figure B-12: Pulse Adjusted to Four Major Divisions in Height

18. Press STORE.
19. Return the NOISE FILTER control to 1 avg.

20. Place the baseline of the waveform on the center graticule using the ∇ POSITION control.
21. Increase VERT SCALE to 30.00 dB.
22. Using the \triangleleft \triangleright POSITION control, verify that the aberrations are less than four divisions high out to 30 feet (9.15 m)

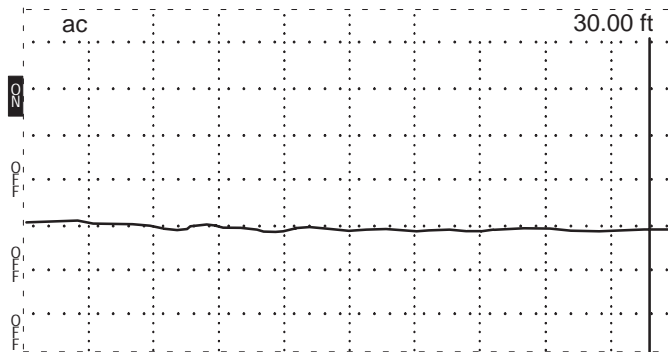

Figure B-13: Aberrations Less Than Four Divisions Out to 30.00 ft

23. Return the cursor to -2.00 ft (-0.61 m).
24. Turn NOISE FILTER back to VERT SET REF.
25. Set the DIST/DIV to 50 ft/div (10 m/div).
26. Turn PULSE WIDTH to 100 ns.
27. Adjust the pulse height to four major divisions.

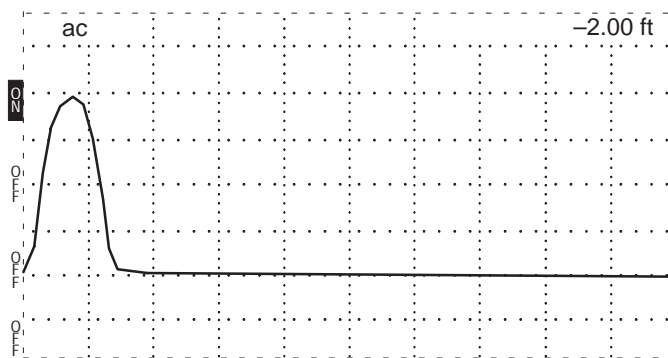

Figure B-14: Pulse Adjusted to Four Major Divisions in Height

28. Press STORE.
29. Return the NOISE FILTER control to 1 avg.

30. Place the baseline of the waveform on the center graticule using the Δ POSITION control.
31. Increase VERT SCALE to 30.00 dB.
32. Using the \triangleleft \triangleright POSITION control, verify that the aberrations are less than four divisions high out to 300 feet (91.50 m)

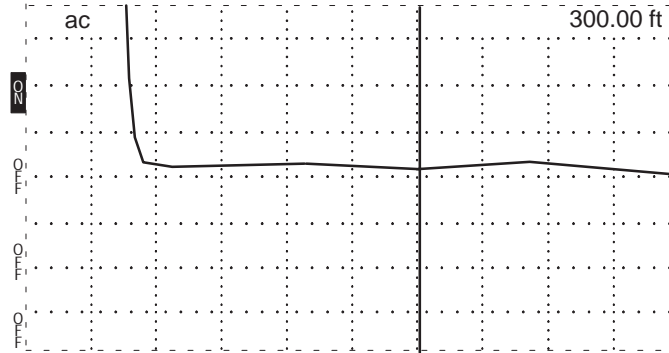

Figure B-15: Aberrations Less Than Four Divisions Out to 300.00 ft

33. Return the cursor to -2.00 ft (-0.61 m).
34. Turn NOISE FILTER back to VERT SET REF.
35. Set the DIST/DIV to 500 ft/div (10 m/div).
36. Turn PULSE WIDTH to 1000 ns.
37. Adjust the pulse height to four major divisions.

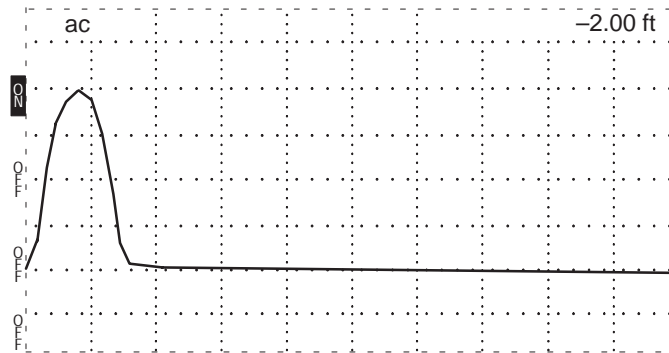

Figure B-16: Pulse Adjusted to Four Major Divisions in Height

38. Press STORE.
39. Return the NOISE FILTER control to 1 avg.
40. Place the baseline of the waveform on the center graticule using the Δ POSITION control.

41. Increase VERT SCALE to 30.00 dB.
42. Using the \triangleleft \triangleright POSITION control, verify that the aberrations are less than four divisions high out to 3000 feet (915.00 m)

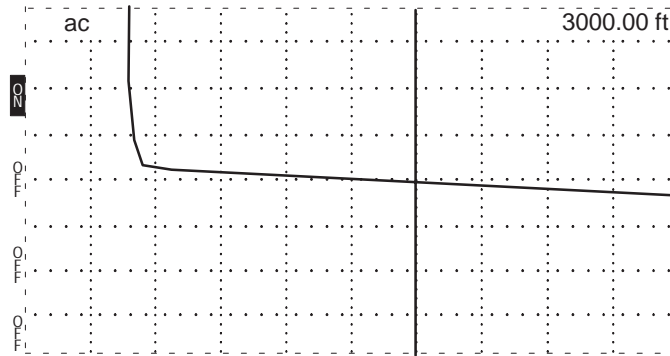

Figure B-17: Aberrations Less Than Four Divisions Out to 3000.00 ft

Conclusions

If the instrument failed Aberrations or Sampling Efficiency checks, it is probably still adequate for all but extremely minor fault measurements. If it failed the Horizontal Scale check, you should not use the instrument until the cause of the failure has been identified and corrected.

All of the previous checks only test the major functional blocks of the instrument that could prevent you from being able to make measurements. It is possible for the front-panel controls or the LCD to have problems that would interfere with controlling or displaying measurements. Most problems of this type would become evident as you perform the checks. If you suspect a problem of this nature, you should have the instrument checked by a qualified service technician, using the diagnostics in the *1503C Service Manual*.

If the instrument passed all of the previous checks, it is ready for use.

If your instrument is equipped with Option 06 (Ethernet), refer to the *Calibration* section of the *1503C Service Manual*.

Appendix C: Operator Troubleshooting

For assistance in troubleshooting, use the following flow chart to determine if you have a simple problem you can fix or if the instrument needs to be sent to a Tektronix Service Center.

Use this process to determine whether the instrument should be repaired or is OK to use when you have a problem.

CAUTION: Any time the instrument smells hot, repeatedly blows fuses, or repeats the same error message, you should have the instrument serviced by qualified technicians using the procedures in the *1503C Service Manual*.

These are the first checks you should perform when you think you might have a problem with the instrument.

The first step asks you to preset the instrument controls. Here is how to do that: Set V_p to .66; turn the IMPEDANCE knob all the way counterclockwise; turn the FILTER knob all the way counterclockwise, then back two clicks; turn the DIST/DIV knob all the way counterclockwise, then back three clicks; turn the PULSE WIDTH knob all the way counterclockwise; remove any accessories that might be plugged into the Option Port (e.g., chart printer), and disconnect any cable that might be attached to the front-panel connector.

To complete the tests, you might need a Volt–Ohmmeter (VOM), a flat-bladed screw driver (to set the line voltage switch) and possibly, some spare fuses.

When you have completed these tests, you will know that it is safe to use the instrument or that it needs repair or adjustment internally. You do not remove the case for these tests.

IMPORTANT: It is possible for the instrument to continue to make some measurements even after reporting an error message. Do not ignore repeated error messages! They indicate something is wrong and should be used with the *1503C Service Manual* troubleshooting procedures.

This procedure will give you confidence that the instrument is functioning properly. It is not an exhaustive set of tests that guarantee that the instrument meets all specifications and is perfectly calibrated. The calibration procedures in the *1503C Service Manual* are the best method for assuring that the instrument meets all specifications.

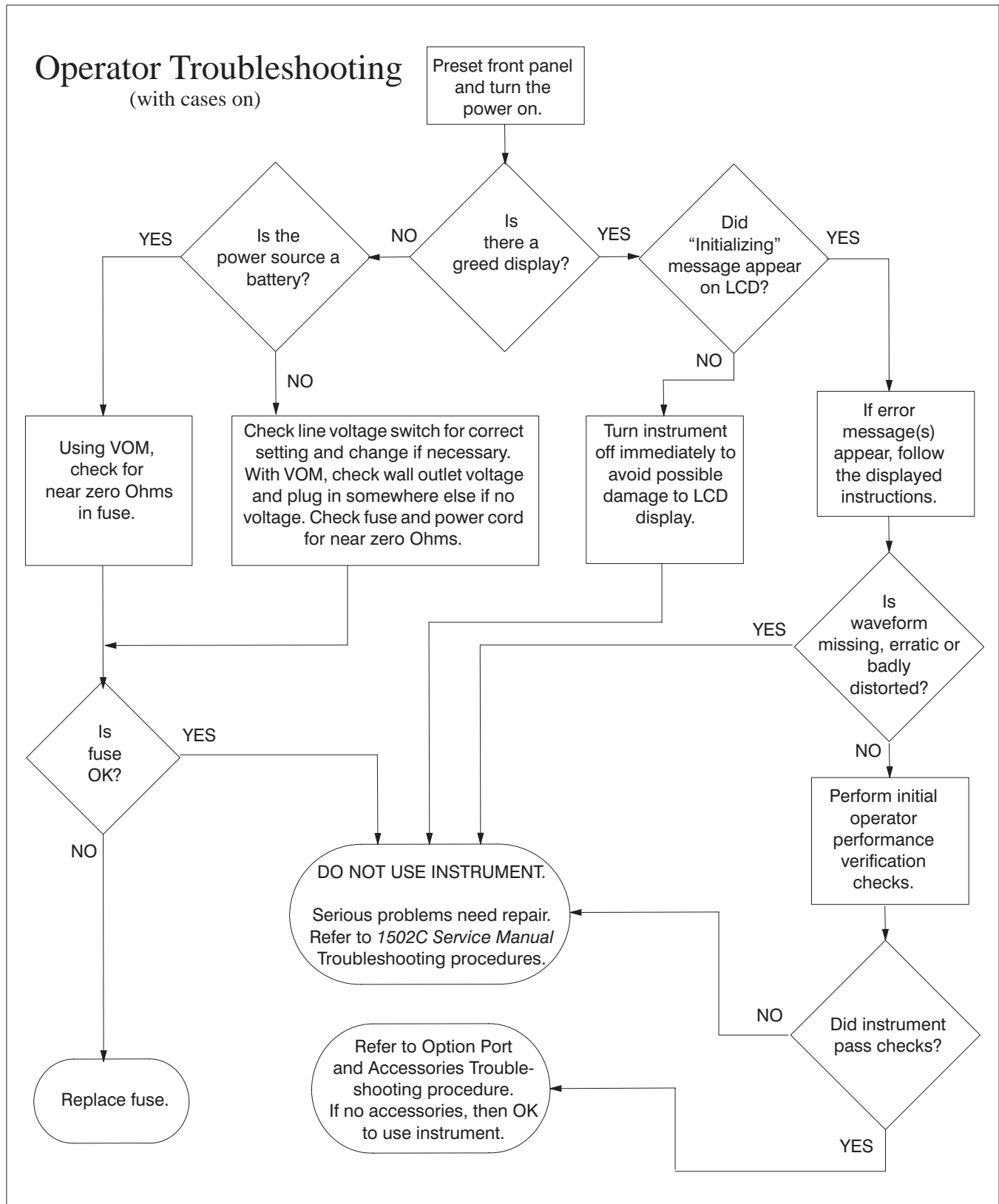

Error Messages

Any time the instrument displays an error message, the troubleshooting procedures should be used to judge the extent and severity of the problem.

Some errors will still permit some kinds of measurements. If there is any doubt about the ability to make a particular kind of measurement, do not make that measurement until the problem has been corrected.

Message: **Option Port Device Not Responding...
Please check for correct installation.**

– push MENU button to Continue –

Occurrences: This can occur anytime a chart printer, SP-232, or other Option Port device requests attention from the TDR.

Meanings: This error indicates that the TDR has received a signal indicating a request from the Option Port device and either there is no device installed or the device is not responding with a recognized ID byte when polled by the TDR.

This error might be very annoying because the Option Port is checked once each time the TDR gets a waveform. If the TDR is being controlled by or through the Option Port device, you will probably have to remove that device and make manual measurements until the failure is corrected.

This type of failure will not affect measurements made manually.

Remedies: If there is no Option Port device, there is probably a failure in the option port logic circuitry on the main circuit board, or in the cable between the main board and the Option Port connector. Refer the instrument to a qualified service technician.

If the error is in response to a chart printer request, the PRINT switch on the chart printer, or the wires to that switch, are probably bad or shorted to the chassis or other ground point. Refer the chart printer to a qualified service technician.

If the error is in response to another Option Port device, remove that device. If the error ceases, have the device serviced. If the error persists, have the TDR serviced.

Message: **ERROR: Acquisition Initialization
TYPE: Leading edge of pulse not found**

**ERROR: Acquisition Initialization
TYPE: Top of 50nsec ramp not found**

Occurrences: This message can occur at power on initialization only. These are common error messages because they are triggered by many kinds of failures and come from one of the very first routines that the instrument executes.

Meanings: The instrument searches for a point on the leading edge of the pulse that is on the cable inside the instrument (about 10% up the pulse). This message indicates that the search failed. This could be because the pulse is not there, or because the sampler or gain circuitry is broken, or even because the timebase is not functioning properly.

Remedies: The instrument must be sent to service for repair.

Appendix D: Application Note

Pulse Echo Testing of Electrical Transmission Lines Using the Tektronix Time-Domain Reflectometry Slide Rule

Introduction

Most people who make quantitative reflectometry tests or measurements should find the Tektronix TDR Slide Rule helpful. Those new to the subject will find the slide rule graphically summarizes a wealth of information on reflectometry.

- Voltage Standing Wave Ratio vs. Percent Reflected Voltage
- Return Loss, dB, vs. Percent Reflected Voltage
- Percent Reflected Voltage vs. Characteristic Line Impedance (for either 50 Ω or 75 Ω source)
- Percent Reflected Voltage vs. Load Resistance (for either 50 Ω or 75 Ω source)
- Characteristic Line Impedance or Load Resistance vs. Reflection Amplitude (as seen on your TDR)
- Dielectric Constant vs. Velocity Factor
- Time vs. Short Distance in centimeters or inches (any dielectric)
- Time vs. Long Distances in meters or feet (any dielectric)

Terms and Symbols

R_S	... Source Resistance of a signal generator
Z_S	... Source Impedance of a signal generator
Z_O	... Characteristic Impedance of a transmission line
Z_L	... Load Impedance for a transmission line
R_L	... Load Resistance for a transmission line
ρ	... Reflection Coefficient (rho): the ratio of incident to reflected voltage
m ρ	... Reflection Coefficient divided by 1,000 (millirho)
%	... Ratio of the incident voltage to reflected voltage multiplied by 100
VSWR	Voltage Standing Wave Ration (peak-to-valley)
c	... Velocity of light in air
V_P	... Propagation Velocity of a signal in a transmission line
V_t	... Velocity Factor (fraction of the velocity of light)
κ	... Dielectric Constant
D	... Outer Diameter of the dielectric in a coaxial cable
d	... Diameter of the center conductor in a coaxial cable
L	... Inductance in nanoHenries (nH) per foot
C	... Capacitance in picoFarads (pF) per foot

Relationships

$$Z_0 = (138 / \sqrt{\kappa}) * (\log_{10} D / d) \text{ for coaxial cable}$$

$$\% = \rho * 100$$

$$\text{VSWR} = (1 + \rho) + (1 - \rho) \text{ for the case where VSWR is the same for all frequencies}$$

$$c = 30 \text{ cm / nanosecond} = 0.984 \text{ ft / ns}$$

$$V_F = 1 / \sqrt{\kappa}$$

$$V_P = 30 / \sqrt{\kappa} \text{ cm / ns} = 0.984 / \sqrt{\kappa} \text{ ft / ns}$$

$$C = 7.36 \kappa + (\log_{10} D / d)$$

$$L = 140 \log_{10} D / d$$

$$1 \text{ in} = 2.54 \text{ cm}$$

$$1 \text{ ft} = 30.48 \text{ cm}$$

$$1 \text{ m} = 3.28 \text{ ft}$$

VSWR vs. Percent Reflected Voltage

To find the Voltage Standing Wave Ratio (VSWR), knowing the percent reflected voltage (%), or vice versa, use the Frequency Domain Conversions section of the slide rule (see Figure AN-1).

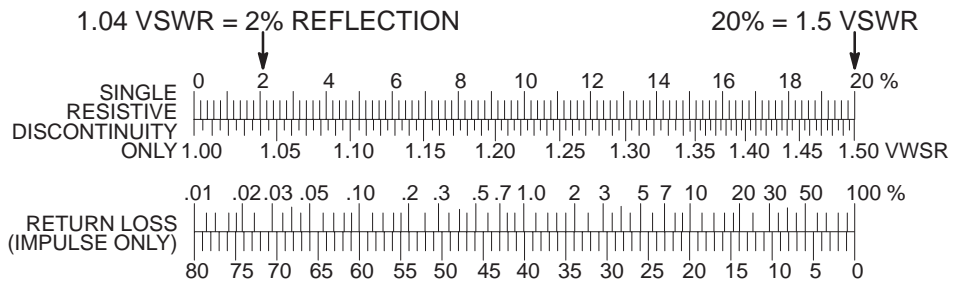

Figure D-1: Slide Rule of VSWR vs. Percent Reflected Voltage

On the upper scale, locate the known value of VSWR (or %). Adjacent to that point is the corresponding value for % (or VSWR). VSWR is the peak-to-valley ratio of standing sine waves.

NOTE. The relationship between % holds only when the loss is a single impedance discontinuity with negligible capacitive or inductive components (e.g., a 75 Ω termination at the end of a 50 Ω cable). The VSWR must be essentially the same for all sine-wave frequencies.

Return Loss (dB) vs. Percent Reflected Voltage

To find return loss in decibels, knowing the % (or vice versa), use the bottom scale of the Frequency Domain Conversions section of the slide rule (see Figure AN–2).

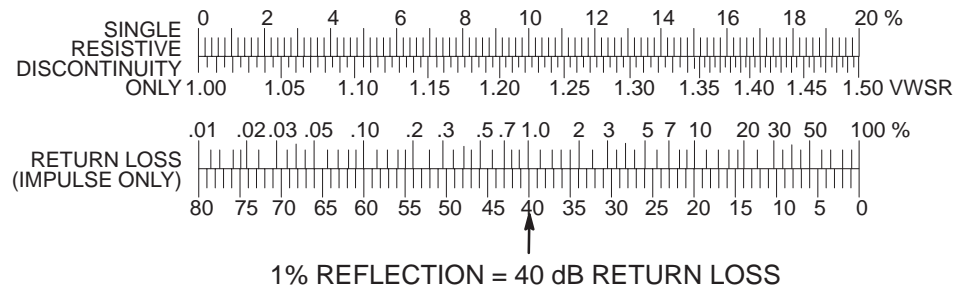

Figure D-2: Slide Rule of Return Loss vs. Percent Reflected Voltage

Locate the known value of % or the known dB return loss, then locate the value of the corresponding expression on the adjacent scale.

NOTE. Only the impulse mode of Time-Domain Reflectometry can be accurately expressed in terms of return loss.

A narrow impulse will be attenuated by losses in the cable and reflections will be attenuated likewise.

As with measurements on VSWR, there is only a simple mathematical relationship between reflection measurements using sine waves and reflection measurements using pulses when one resistive discontinuity is the whole cause for the sizable reflections.

Percent Reflected Voltage vs. Characteristic Line Impedance (50 Ω or 75 Ω Source)

To find the characteristic impedance of a line, or section of a line, knowing the reflection coefficient or the %, you should first know the impedance of the pulse generator. It should be as close as possible to the nominal impedance of the line and should be connected to the line through a length of cable having the same impedance as the source. Select the side of the slide rule that corresponds to the source resistance (R_S) of the generator used, then select the longest scale as follows:

Size of Reflection	% / division	ρ / division
100% to 80% (1 ρ to 0.8 ρ)	20	.20
80% to 40% (0.8 ρ to 0.4 ρ)	10	.10
40% to 16% (0.4 ρ to 0.16 ρ)	5	.05
16% to 8% (0.16 ρ to 0.08 ρ)	2	.02
8% to 4% (0.08 ρ to 0.04 ρ)	1	.01
4% or less (< 0.04 ρ)	0.5	.005

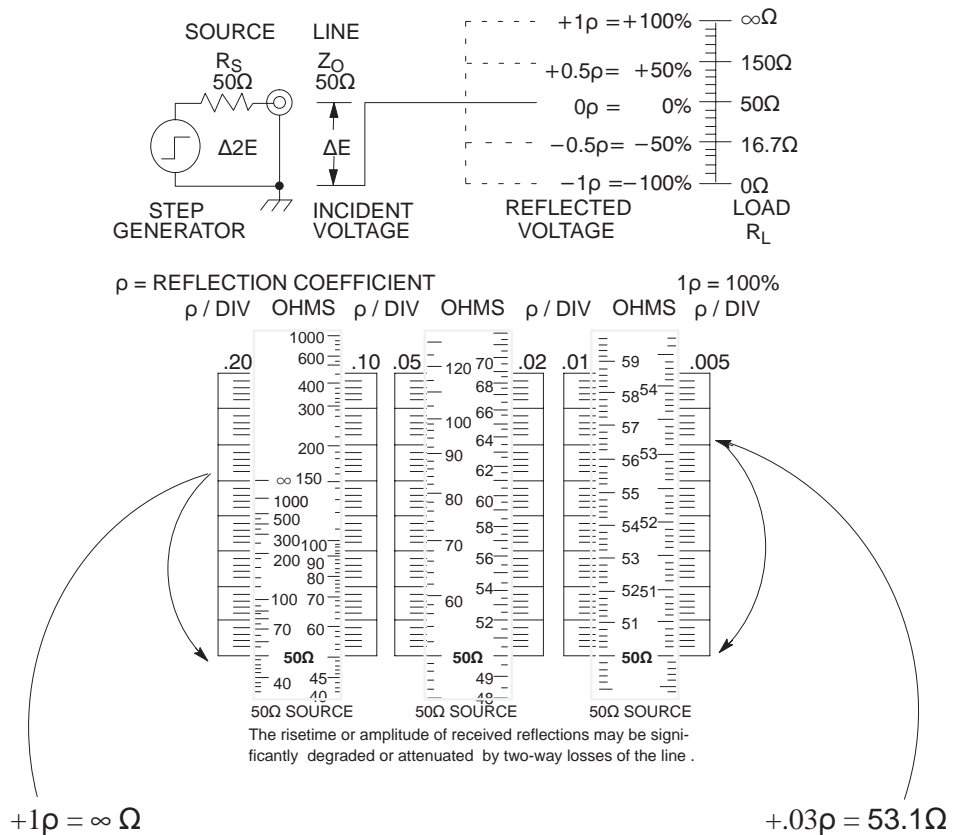

Figure D-3: Slide Rule 50 Ω Source

If the reflection is downward from the 50 Ω or 75 Ω reference level, set the reference level to the top of the chosen scale. If the reflection is toward a higher impedance than the reference level, set the reference level to the bottom of the chosen scale. Then count off the right number of divisions and subdivisions to locate the level corresponding to the peak of the reflection and read the corresponding impedance levels (Ohms) on the adjacent sliding scale.

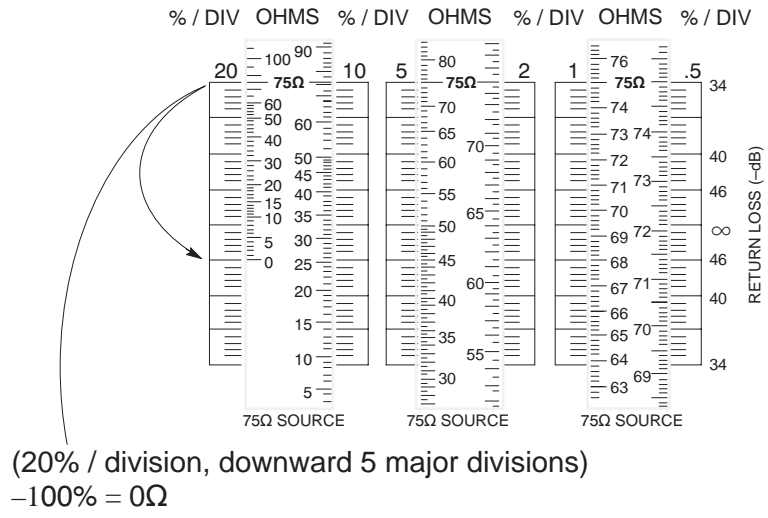
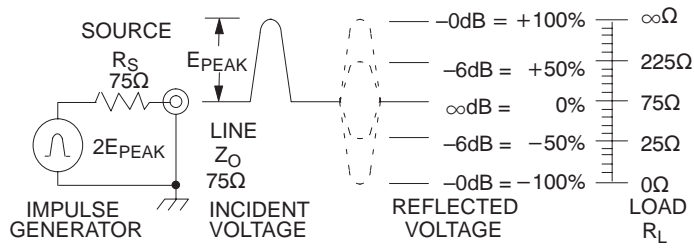

Figure D-4: Slide Rule 75 Ω Source

If the line impedance and the source resistance are known, the expected amplitude of a reflection can be approximated. First, select the side of the slide rule having the correct source impedance. For cables having a higher impedance than the selected source resistance, put the sliding reference level even with the bottom stationary scale markings. For cables having a lower impedance than the selected source resistance, move the reference level even with the top of the scale markings. For best accuracy, select the scale farthest to your right in which the impedance level of interest is in view. Read from the adjacent stationary scale the reflection coefficient or percent reflected voltage that corresponds to the Ohms selected.

Percent Reflected Voltage vs. Load Resistance

To find the terminating load resistance (R_L) of a line, knowing the percent reflected voltage or reflection coefficient, use the preceding instructions.

If the load resistance is known, the previous procedures can be used to approximate the size of the return reflection. An error might be introduced if the impedance of the connecting cable does not match the source resistance of the pulse generator.

Characteristic Line Impedance or Load Resistance vs. Reflection Amplitude (as seen on your TDR)

Line Impedance (Z_0) or Load Resistance (R_L) can be derived directly from the amplitude of a reflection displayed on a TDR display. The displayed reflection should be positioned vertically to a known $50\ \Omega$ reference level. For a reference level, use either a section of line of known impedance ahead of the line under test/load, or use a termination of known resistance at the end of the line. The slide rule can then be used by selecting the side with the same source resistance and the same scale as the TDR.

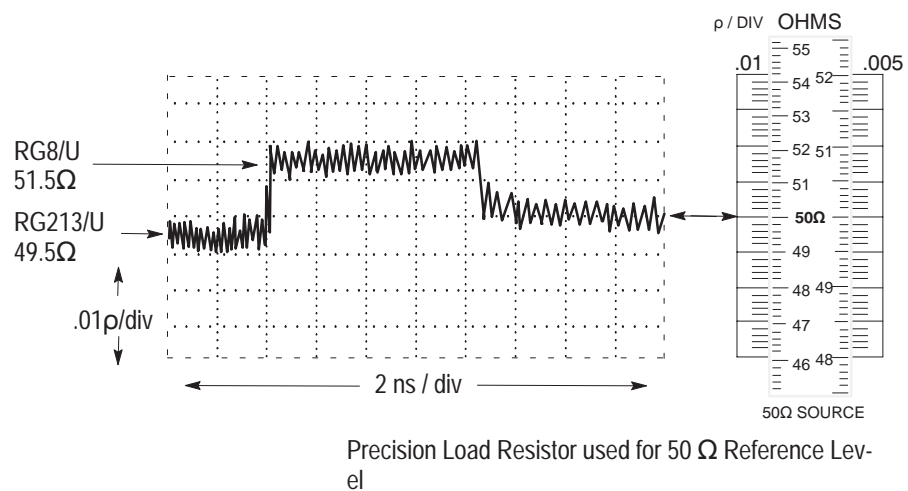

Figure D-5: Calculating Resistance/Impedance from Waveform Amplitude

Position the $50\ \Omega$ or $75\ \Omega$ reference level on the sliding scale to correspond with the one selected as the reference level on the TDR display. The impedance (Ohms) causing the reflection can then be read from the sliding scale by noting the position on the fixed scale that corresponds to the position of the reflection on the TDR display.

You should note that the peak level of any reflection that does not have a discernable plateau might be an erroneous indication of the impedance discontinuity that caused it. There might be several reasons for the error. 1) The discontinuity might occupy such a short segment of the line compared to the V_P of the line and the risetime of the test pulse wavefront that part of the wavefront starts to emerge from the segment while the remainder is still entering. This causes a spike-shaped reflection, the amplitude of which might vary depending on the risetime of the test pulse, how badly the risetime has been degraded by the cable before it arrives, and how much attenuation the cable might impose on the reflection before it arrives back at the source. 2) If the risetime of the TDR system is too long, a reflection with a plateau will appear as a spike.

Centimeters vs. Inches or Meters vs. Feet

Inches and Centimeters: A given number of inches can be converted to centimeters by placing the point on the sliding scale that corresponds to that number next to the stationary arrow labeled INCHES, then reading the distance in centimeters next to the point of the arrow labeled CENTIMETERS. Likewise, centimeters are converted to inches using these directions in reverse.

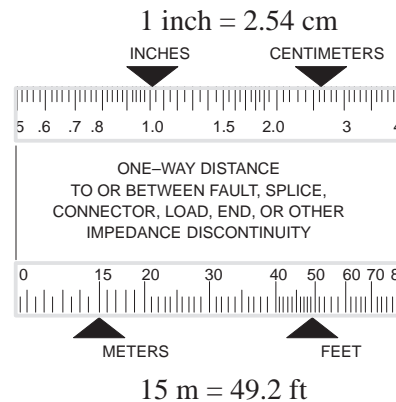

Figure D-6: English-Metric, Metric-English Conversion Scales

Meters and Feet: A given number of meters can be converted to feet by placing the point on the sliding scale that corresponds to that number next to the stationary arrow labeled METERS, then reading the distance in feet next to the point of the arrow labeled FEET. Likewise, feet are converted to meters using these directions in reverse.

Dielectric Constant vs. Velocity Factor

Dielectric Constant and Velocity Factor appear on two identical scales next to a sliding scale labeled ROUND TRIP TIME. To find one, knowing the other, read across the sliding scale. Any major division on the sliding scale can be placed next to the known value to help read directly across the sliding scale.

Time vs. Short Distances, in Centimeters or Inches (any dielectric)

To find the distances to or between discontinuities in a transmission line, knowing the time for a pulse edge to travel that distance and back (round trip time), it is necessary to know either the dielectric constant of the material between the conductors or the velocity factor of the line. For distances less than about three meters (or 10 feet), use the INCHES and CENTIMETERS scale.

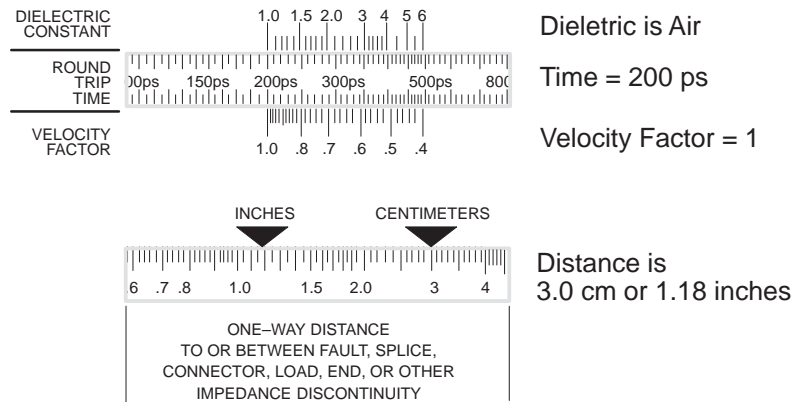

Figure D-7: Dielectric Constant and Velocity Factor, Short Distance

The round trip time should be located on the sliding scale that is above the INCHES and CENTIMETERS scale. Place the point on the sliding scale next to a point on one of the stationary scales that corresponds to the value of the dielectric constant or velocity factor. Then read the distance on the INCHES and CENTIMETERS scale.

If the distance to or between faults is known and you want to find the time or velocity factor, set the distance under the appropriate arrow first, then read the answer on the ROUND TRIP TIME scales.

Time vs. Long Distances, in Meters or Feet (any dielectric)

Distances to or between discontinuities farther apart than about three meters (10 feet) can be found on the METERS and FEET scale. Use the sliding ROUND TRIP TIME scale just below it and follow the same procedure as above.

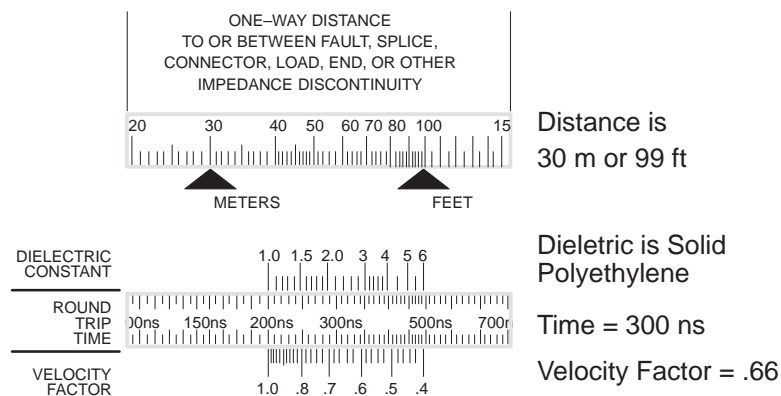

Figure D-8: Dielectric Constant and Velocity Factor, Long Distance

Glossary

Aberrations	Imperfections or variations from a desired signal. In TDRs, a pulse of electrical energy is sent out over the cable. As the pulse-generating circuitry is turned on and off, the pulse is often distorted slightly and no longer is a perfect step or sine-shaped waveform.
AC	Alternating current is a method of delivering electrical energy by periodically changing the direction of the flow of electrons in the circuit or cable. Even electrical signals designed to deliver direct current (DC) usually fluctuate enough to have an AC component.
Accuracy	The difference between a measured, generated, or displayed value and the true value.
Cable	Electrical conductors that are usually insulated and often shielded. Most cables are made of metal and are designed to deliver electrical energy from a source (such as a radio transmitter) across a distance to a load (such as an antenna) with minimal energy loss. Most cables consist of two conductors, one to deliver the electrical signal and another to act as a return path, which keeps both ends of the circuit at nearly the same electrical potential. In early electrical systems and modern systems that over long distances use the earth and/or air as the return path, and the term “ground” or “ground wire” is often used to describe one of the wires in a cable pair.
Cable Attenuation	The amount of signal that is absorbed in the cable as the signal propagates down it. Cable attenuation is typically low at low frequencies and higher at high frequencies and should be corrected for in some TDR measurements. Cable attenuation is usually expressed in decibels at one or several frequencies. See also: dB and Series Loss.
Cable Fault	Any condition that makes the cable less efficient at delivering electrical energy than it was designed to be. Water leaking through the insulation, poorly mated connectors, and bad splices are typical types cable faults.
Capacitance	(see Reactance)
Characteristic Impedance	Cables are designed to match the source and load for the electrical energy that they carry. The designed impedance is often called the characteristic impedance of the cable. The arrangement of the conductors with respect to each other is the major factor in designing the impedance of cables.

Conductor	Any substance that will readily allow electricity to flow through it. Good conductors are metals such as silver, copper, gold, aluminum, and zinc (in that order).
dB	dB is an abbreviation for decibel. Decibels are a method of expressing power or voltage ratios. The decibel scale is logarithmic. It is often used to express the efficiency of power distribution systems when the ratio consists of the energy put into the system divided by the energy delivered (or in some cases, lost) by the system. Our instrument measures return loss. The formula for decibels is: $dB = 20 \log (V_i/V_r)$ where V_i is the voltage of the incident pulse, V_r is the voltage reflected back by the load, and \log is the decimal-based logarithmic function. The dB vertical scale on our instrument refers to the amount of voltage gain (amplification) the instrument applies to the signal before displaying it. For example, when the instrument is amplifying the voltage by one hundred, the dB scale would read 40 dB, which is $20 \log 100$.
DC	Direct current is a method of delivering electrical energy by maintaining a constant flow of electrons in one direction. Even circuits designed to generate only AC often have a DC component.
Dielectric	(see Insulation)
Domain	A mathematical term that refers to the set of numbers that can be put into a function (the set of numbers that comes out of the function is called the “range”). A time-domain instrument performs its function by measuring time.
Impedance	The total opposition to the flow of electrical energy in a cable or circuit. Impedance is made partly of resistance (frequency independent) and partly of reactance (frequency dependent). Although impedance is expressed in units of Ohms, it must not be confused with the simple resistance that only applies to DC signals. Technically, impedance is a function of the frequency of the electrical signal, so it should be specified at a frequency. As a practical matter, the impedance of most cables changes very little over the range of frequencies they are designed for.
Impedance Mismatch	A point in a cable or system where the incident electrical energy is redistributed into absorbed, reflected, and/or transmitted electrical energy. The transmitted electrical energy after the mismatch is less than the incident electrical energy.
Incident Pulse	The pulse of electrical energy sent out by the TDR. The waveform shown by the TDR consists of this pulse and the reflections of it coming back from the cable or circuit being tested.
Inductance	(see Reactance)

- Insulation** A protective coating on an electrical conductor that will not readily allow electrical energy to flow away from the conductive part of the cable or circuit. Insulation is also called dielectric. The kind of dielectric used in a cable determines how fast electricity can travel through the cable (see Velocity of Propagation).
- Jitter** The short term error or uncertainty in the clock (timebase) of a TDR. If the timing from sample to sample is not exact, the waveform will appear to move back and forth rapidly.
- LCD** An acronym for Liquid Crystal Display. It is the kind of display used on this instrument, so the terms display and LCD are often used interchangeably.
- Millirho** rho (ρ) is the reflection coefficient of a cable or power delivery system. It is the ratio of the voltage reflected back from the cable or circuit due to cable faults or an impedance mismatch at the load, divided by the voltage applied to the cable. Millirho are thousandths of one rho. Rho measurements are often used to judge how well the cable is matched to the load at the other end of the cable. If there is an open circuit in the cable, nearly all the energy will be reflected back when a pulse is sent down the cable. The reflected voltage will equal the incident pulse voltage and rho will be +1. If there is a short circuit in the cable, nearly all the energy will be delivered back to the instrument through the ground or return conductor instead of being sent to the load. The polarity of the reflected pulse will be the opposite of the incident pulse and rho will be -1. If there is no mismatch between the cable and the load, almost no energy will be reflected back and rho will be 0. In general, a load or fault with higher impedance than the cable will return a rho measurement of 0 to +1, and a load or fault with a lower impedance will return a rho measurement of 0 to -1. The scale for rho measurements is determined by the height of the incident pulse. A pulse two divisions high means that each division is 0.5 rho (500 millirho). A pulse set to be four divisions high would make each division 0.25 rho (250 millirho).
- Noise** Any unwanted electrical energy that interferes with a signal or measurement. Most noise is random with respect to the signals sent by the TDR to make a measurement and will appear on the waveform, constantly constantly moving up and down on the display. The NOISE FILTER control sets how many waveforms will be averaged together to make the waveform displayed. Noisy waveforms appear to fluctuate around the real signal. Because it is random, noise will sometimes add to the real signal and sometimes subtract energy from the real signal. By adding several noisy waveforms together, the noise can be “averaged” out of the signal because the average amount of noise adding to the signal will be nearly the same as the average amount of noise subtracting from the signal. More waveforms in an average are more likely to approach the real signal (although it takes longer to acquire and add together more waveforms).

Open Circuit	In a cable, a broken conductor will not allow electrical energy to flow through it. These circuits are also called broken circuits. The circuit is open to the air (which looks like a very high impedance).
Precision	The statistical spread or variation in a value repeatedly measured, generated, or displayed under constant conditions. Also called repeatability.
Reactance	A conductor's opposition to the flow of AC electrical energy through it. All conductors have some reactance. Reactance is made up of capacitance and inductance. Capacitance is the ability of conductors separated by thin layers of insulation (dielectric) to store energy between them. Inductance is the ability of a conductor to produce induced voltage when the electrical current through it varies. All conductors have some capacitance and inductance, so all conductors have some reactance, which means they all have impedance.
Reflectometer	An instrument that uses reflections to make measurements. Our reflectometers use electrical energy that is reflected back from points along a cable.
Resistance	A conductor's opposition to the flow of DC electrical energy through it. All conductors have a certain amount of resistance. Resistance is the low (or zero) frequency part of impedance.
Resolution	For a given parameter, the smallest increment or change in value that can be measured, generated, or displayed.
Return Loss	The amount of energy reflected or returned from a cable indicates how much the impedance in the system is mismatched. The ratio of the energy sent out by the TDR, divided by the energy reflected back, expressed in the logarithmic dB scale, is called return loss.
Rho (ρ)	(see Millirho)
Risetime	The time it takes a pulse signal to go from 10% to 90% of the change in voltage.
RMS	An acronym for Root Mean Squared. RMS is a way of measuring how much deviation there is from a known (or desired) waveform. It is also the method used to calculate how much power is contained in an AC waveform.
Sampling Efficiency	Our instruments make measurements by taking a succession of samples in time and displaying them as a waveform with voltage on the vertical scale (up and down) and

time along the horizontal scale (across the display). The circuitry that captures and holds the samples cannot instantly change from one voltage level to another. It might take the circuit several samples to settle in at the new voltage after a rapid change in the waveform. How efficiently the circuit moves from one sampled voltage level to the next is called sampling efficiency. If the efficiency is too low, the waveforms will be smoothed or rounded. If the efficiency is too high (above 100%), the circuit will actually move beyond the new voltage level in a phenomenon known as overshoot, which becomes an unwanted source of noise in the waveform.

Series Loss Conductors all have some DC resistance to the flow of electrical energy through them. The amount of resistance per unit length is usually nearly constant for a cable. The energy lost overcoming this series resistance is called series loss. The series loss must be compensated for when measuring the return loss or impedance mismatch at the far end of long cables.

Short Circuit In a cable, a short circuit is a place where the signal conductor comes into electrical contact with the return path or ground conductor. The electrical circuit is actually shorter than was intended. Short circuits are caused by worn, leaky, or missing insulation.

Stability The change in accuracy of a standard or item of test equipment over an extended period of time. Unless otherwise specified, the period of time is assumed to be the calibration interval (might also apply to range, resolution, or precision as a function of time). The term stability might also be used to denote changes resulting from environmental influences, such as temperature, humidity, vibration, and shock.

TDR An acronym for Time-Domain Reflectometer. These instruments are also called cable radar. They send out pulses of energy and time the interval to reflections. If the velocity of the energy through the cable is known, distances to faults in the cable can be displayed or computed. Conversely, the speed that the energy travels through a cable of known length can also be computed. The way in which the energy is reflected and the amount of the energy reflected indicate the condition of the cable.

Velocity of Propagation (Vp) Electrical energy travels at the same speed as light in a vacuum. It travels slower than that everywhere else. The speed that it travels in a cable is often expressed as the relative velocity of propagation. This value is just a ratio of the speed in the cable to the speed of light (so it is always a number between 0 and 1). A velocity of propagation value of 0.50 indicates that the electrical energy moves through the cable at half the speed of light.

Waveform Averaging (see Noise)

Index

A

- AC (see Power)
- Accessories, 3–19
 - Optional, 3–19
 - Standard, 3–19
- accessories, standard, 3–19
- Altitude Spec, A–3
- Application Note, D–1

B

- Battery (see Power)
- Battery Pack Spec, A–2
- BNC Connector, 3–19
- Bridge, 3–2

C

- Cable
 - Length vs. Pulse, 1–13, 2–9
 - Open, 1–14
 - Scrolling, 2–7
 - Short, 1–13, 2–16
 - Test Procedure, 1–12
 - Distance to Fault, 1–12
 - Horizontal Set Reference, 1–21
 - Reflection Coefficient, 1–16
 - Return Loss, 1–15
 - Store Waveform, 1–18
 - Vertical Set Reference, 1–23
 - View Difference, 1–18
 - View Input, 1–17
 - View Store, 1–18
- Cable Connection Spec, A–2
- Cable Types, 1–11
- Carrier, 3–2, 3–9
- Characteristics
 - Electrical, A–1, A–2, A–3
 - Ethernet, 3–16
 - Environmental, A–3
 - Physical, A–4
- Cheapernet, 3–1
- Checks (see Performance Checks)
- Collision, 3–2
- Connectors
 - BNC – BNC, 3–19
 - BNC to Alligator, 3–19
 - BNC to Banana, 3–19

- BNC to Binding Post, 3–19
- BNC to F Type, 3–20
- BNC to GR, 3–20
- BNC to Hook Tips, 3–19
- BNC to N Type, 3–19
- BNC to UHF, 3–19

Controls

- Cable Connector, 1–5
- Distance / Division, 1–5
- Front Panel, 1–4, 1–5
- Horizontal Position, 1–6
- Impedance, 1–5
- Menu Button, 1–6
- Noise Filter, 1–5
- Power, 1–6
- Pulse Width, 1–6
- Store Button, 1–6
- Velocity of Propagation, 1–6
- Vertical Position, 1–6
- Vertical Scale, 1–5
- View Difference Button, 1–6
- View Input Button, 1–6
- View Store Button, 1–6

- Cursor Spec, A–2

D

- Delta Mode, 2–11
- Depth Spec, A–5

E

- Electromagnetic Spec, A–4
- Error Messages, C–3
- Ethernet, Test Procedure, 3–5
- Ethernet
 - Bridge, 3–2
 - Carrier, 3–9
 - Collision, 3–10
 - Custom Tests, 3–10
 - Electrical Characteristics, 3–16
 - Frequency Response Curve, 3–17
 - Introduction, 3–4
 - Menu, 3–7
 - Carrier, 3–8
 - Collision, 3–9
 - Single Sweep, 3–8
 - Termination, 3–7
 - N-Type Female T-Connector, 3–6

- N-Type Male T-Connector, 3–5
- Repeaters, 3–2
- Segments, 3–2
- Servers, 3–2
- Specifications, 3–16
- Taps, 3–2, 3–10
- Termination, 3–9, 3–10
- Testing Networks, 3–3
- Transceivers, 3–2
- Typical System, 3–3
- What is it?, 3–1
- Waveform Signatures, 3–10

F

- Features (see Menu), 1–24
- Frequency Response Curve, 3–17
- Fungus Spec, A–3
- Fuse, 3–19
- Fuse (see Power), 1–2

G

- Getting Started, 2–2

H

- Handling, 1–1
- Height Spec, A–5
- Help, 2–1
- Horizontal Scale Spec, A–2
- Horizontal Set Reference, 1–21, 2–11
- HORZ SET REF (see Horizontal Set Reference), 2–11
- Humidity Spec, A–3

I

- Impedance (see also Controls), 1–5
- Impedance of Cables, 1–11
- Indicators, 1–5
- Isolation Network, 3–20

L

- Loss, 1–15

M

- Maintenance, C–1, D–1
- Max Hold (see Maximum Hold), 2–18

- Maximum Hold, 1–24, 2–18
- Menu, 1–7, 1–24, 2–1, 2–18
 - Cables, 1–7
 - Diagnostics, 1–8
 - Chart Recorder, 1–9
 - Head Alignment, 1–9
 - LCD Chart, 1–9
 - Front Panel, 1–8
 - LCD, 1–8
 - Alignment, 1–8
 - Contrast, 1–9
 - Drive Test, 1–9
 - Response Time, 1–8
 - Service, 1–8
 - Impedance, 1–8
 - Noise, 1–8
 - Offset / Gain, 1–8
 - RAM / ROM, 1–8
 - Sampling Efficiency, 1–8
 - Timebase, 1–8
 - Display Contrast, 1–10
 - Impedance, 1–7
 - Main, 1–7
 - Maximum Hold, 1–24
 - Option Port, 1–9
 - Debugging, 1–9
 - Diagnostic, 1–9
 - Timing, 1–9
 - Pulse, 1–25
 - Setup, 1–7
 - Acquisition Control, 1–7
 - Backlight, 1–8
 - Distance / Division, 1–7
 - Maximum Hold, 1–7
 - Pulse, 1–7
 - Single Sweep, 1–7
 - Vertical Scale, 1–7
 - Single Sweep, 1–26
 - Velocity of Propagation, 1–7
 - View Stored Waveform, 1–9

N

- Noise (see also Controls), 1–5, 2–9
 - Reduced, 2–10
- Noise Filter, 2–11, 2–12, 2–13
- Noise Spec, A–1

O

- Open, 1–14, 2–3
- Option Port Cover, 3–19

Options, vii, 3–1
 Chart Recorder (04), 3–1
 Chart Recorder (07), 3–17
 Ethernet (06), 3–1
 Metric Default (05), 3–1
 Power Cords, 3–18
 Token Ring Adapter (08), 3–17
 Token Ring Interface (10), 3–18
 USOC (09), 3–18

P

Performance Checks, B–1
 Aberrations, B–6
 Conclusions, B–11
 Equipment Required, B–1
 Horizontal Scale, B–2
 Impedance, B–6
 Noise, B–5
 Offset / Gain, B–5
 Sampling Efficiency, B–6
 Set Up, B–2
 Vertical Position, B–4
 Pouch, 3–19
 Power
 AC Receptacle, 1–2
 Battery, Low Indicator, 1–3
 Battery Pack
 Care of, 1–2
 Charging, 1–2
 Cords, 3–18
 Fuse, 1–2
 Fuse Rating, 1–2
 Voltage Rating, 1–2
 Voltage Selector, 1–2
 Voltages, 1–1
 Pulse (see Controls), 1–6, 1–13, 1–25, 2–1, 2–9, 2–20
 1000ns, 2–8
 100ns, 2–8
 10ns, 2–8
 2ns, 2–7
 Incident, 2–3, 2–5, 2–11, 2–12
 Reflected, 2–3, 2–11, 2–12
 Pulse Inverter, 3–20
 Pulse Spec, A–1

Q

Questions and Answers, 2–23

R

Reflection Coefficient, 1–16
 Repeaters, 3–2
 Return Loss, 1–15

S

Salt Atmosphere Spec, A–3
 Sand and Dust Spec, A–3
 Scale (see Controls)
 Segments, 3–2
 Servers, 3–2
 Service Manual, 3–19
 Ship Carton Strength, ix
 Shock Spec, A–3
 Short, 1–13, 2–4, 2–16
 Single Sweep, 1–26, 2–21
 Slide Rule, 3–19
 Specifications, A–1
 Electrical, A–1, A–2, A–3
 Environmental, A–3
 Physical, A–5
 Store, 2–15
 Store the Waveform, 1–18

T

Taps, 3–2, 3–10
 Temperature, Low, 1–3
 Terminator, 3–2, 3–5, 3–6, 3–9, 3–10, 3–19
 Test Cable, 3–19
 Thin Ethernet, 3–1
 ThinWire, 3–1
 Token Ring
 Adapter, 3–20
 Interface, 3–20
 Transceivers, 3–1
 Troubleshooting, C–1
 Tutorial, 2–1

U

USOC Adapter, 3–20

V

Velocity of Propagation (see also Controls), 1-6, 1-10
 Table of Types, 1-10
 Unknown Vp, 1-11
Velocity of Propagation Spec, A-2
VERT SET REF (see Vertical Set Reference), 2-12
Vertical Scale, 2-5, 2-13
Vertical Scale Spec, A-1
Vertical Set Reference, 1-23, 2-12
Vibration Spec, A-3
View Diff (see View Difference)
View Difference, 1-18, 2-17

View Input, 1-17, 2-14
View Store, 1-18, 2-15
Voltage (see Power)
Voltage Spec, A-2
Vp (see Velocity of Propagation), 1-10

W

Water Resistance Spec, A-3
Waveform Storage, 1-18
Weight Spec, A-5
What is a 1503C?, 2-1

